



capítulo C

capitulo / chapter / chapitre



carregue nas imagens

click en las imágenes
click on the images
cliquez sur les images



Mosquiteiras

Mosquiteiras / Mosquito net / Mostiquaire



Mosquiteira de enrolar vertical

01



Rolos de rede mosquiteira

11

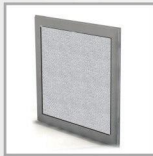

Mosquiteira de correr

03



Mosquiteira fixa

05



Mosquiteira de Harmónio

07



Mosquiteira Roll-out

09

Mosquiteira de enrolar vertical

mosquiteira enrollable vertical / rolling vertical mosquito net
moustiquaire déroulant vertical

C
01

índice



Este artigo tem como função criar uma barreira contra os insetos, e em simultâneo, proporcionar a abertura do mesmo na posição vertical para o desaparecimento deste ou para um acesso exterior da portada.

Aplicação: externa/interna da caixilharia de alumínio.

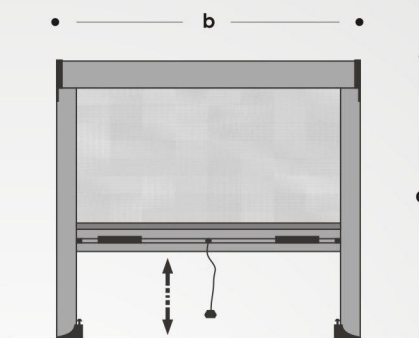

COR color / colour / couleur

Bruto *crudo / raw / brut*

Lacados outros Rall *lacado de otros colores rall / other lacquered colours rall / laqué autres couleurs rall*

Acetinado outros *otros satinado / other satins / autres satins*

		b (mm)							
		< 800	801-1000	1001-1200	1201-1400	1401-1600	1601-1800	1801-2000	2001-2100
a (mm)	< 1000	NIM 01	NIM 02	NIM 03	NIM 04	NIM 05	NIM 06	NIM 07	NIM 08
	1001-1200	NIM 09	NIM 10	NIM 11	NIM 12	NIM 13	NIM 14	NIM 15	NIM 16
	1201-1450	NIM 17	NIM 18	NIM 19	NIM 20	NIM 21	NIM 22	NIM 23	NIM 24
	1451-1600	NIM 25	NIM 26	NIM 27	NIM 28	NIM 29	NIM 30	NIM 31	NIM 32
	1601-1800	NIM 33	NIM 34	NIM 35	NIM 36	NIM 37	NIM 38	NIM 39	NIM 40
	1801-2000	NIM 41	NIM 42	NIM 43	NIM 44	NIM 45	NIM 46	NIM 47	NIM 48
	2001-2200	NIM 49	NIM 50	NIM 51	NIM 52	NIM 53	NIM 54	NIM 55	NIM 56
	2201-2400	NIM 57	NIM 58	NIM 59	NIM 60	NIM 61	NIM 62	NIM 63	NIM 64



El sistema tiene la función de crear una barrera contra insectos y de proporcionar simultáneamente la abertura del mismo en posición vertical para la desaparición de esto o para un acceso exterior del hogar.

Aplicación: marco de aluminio interno y externo.



The system has the function of creating a barrier against insects and it simultaneously provides the same opening in the vertical position to the disappearance of or access to the exterior of the house.

Application: external / internal aluminium frame.



Ce produit a pour fonction de créer une barrière contre les insectes. Ce système permet également une ouverture en position verticale afin de le rendre invisible et de faciliter l'accès à l'extérieur de la maison.

Application: Interne/externe de la fenêtre en aluminium.

Mosquiteira de enrolar vertical

mosquiteira enrollable vertical / rolling vertical mosquito net
moustiquaire déroulant vertical

C
02



índice



Caixas do rolo de rede

Cajons do rolo de rede / Boxes of net roll
Boîtes de déploiement du réseau

alturas e larguras

alturas y anchuras
heights and widths
hauteurs et largeurs

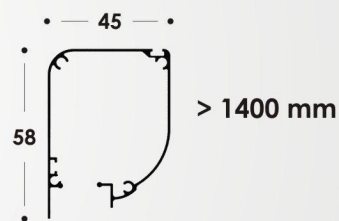
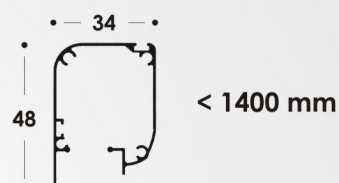

fixação superior
fijación superior
upper anchorage
ancrage supérieur

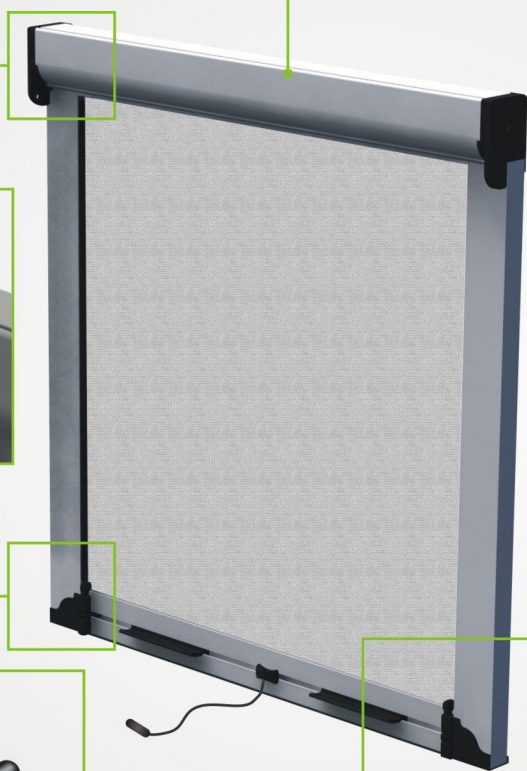

fixação inferior
fijación inferior
lower attachment
fixation inférieure

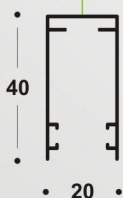

fazendo rodar a fêmea regulámos o travão em altura
by rotating the female regulámos o travão em altura
en tournant le frein de régler la hauteur féminin

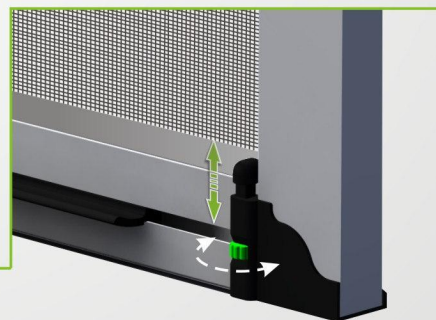

Mosquiteira de correr

mosquiteira corredera / mosquito net sliding system
système de moustiquaire coulissante

C
03

índice



Este artigo tem como função criar uma barreira contra os insetos. Poderá ser acoplado no perfil da porta/janela com movimento.

O artigo, devido às suas características técnicas, permite criar ângulos de 45° sem visualização dos componentes do fecho da esquadria.

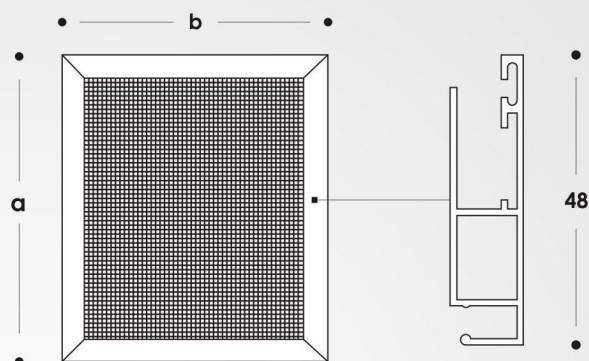

COR color / colour / couleur

Bruto *crudo / raw / brut*

Lacados outros Rall *lacado de otros colores rall / other lacquered colours rall / laqué autres couleurs rall*

Acetinado outros *otros satinado / other satins / autres satins*

• 12 •

		b (mm)							
		250-800	801-1000	1001-1200	1201-1400	1401-1600	1601-1800	1801-2000	2001-2100
a (mm)	250-1000	NIMC 01	NIMC 02	NIMC 03	NIMC 04	NIMC 05	NIMC 06	NIMC 07	NIMC 08
	1001-1200	NIMC 09	NIMC 10	NIMC 11	NIMC 12	NIMC 13	NIMC 14	NIMC 15	NIMC 16
	1201-1450	NIMC 17	NIMC 18	NIMC 19	NIMC 20	NIMC 21	NIMC 22	NIMC 23	NIMC 24
	1451-1600	NIMC 25	NIMC 26	NIMC 27	NIMC 28	NIMC 29	NIMC 30	NIMC 31	NIMC 32
	1601-1800	NIMC 33	NIMC 34	NIMC 35	NIMC 36	NIMC 37	-	-	-
	1801-2000	NIMC 41	NIMC 42	NIMC 43	NIMC 44	NIMC 45	-	-	-
	2001-2200	NIMC 49	NIMC 50	NIMC 51	NIMC 52	NIMC 53	-	-	-
	2201-2400	NIMC 57	NIMC 58	NIMC 59	NIMC 60	NIMC 61	-	-	-



El artículo tiene la función de crear una barrera contra los insectos y puede ser acoplado en el perfil de puertas y ventanas con movimiento. El artículo, debido a sus características técnicas, permite crear ángulos de 45° sin la visualización de los componentes de cierre de la esquadra.



The article has the function of creating a barrier against insects. It can be attached to the profile of the mobile door / window. The article, due to its technical features, allows creating 45° angles without visualization of the components of the closure frame.



Ce produit amovible a pour fonction de créer une barrière contre les insectes. Il pourra être inséré dans le profil de la porte/fenêtre. De part ses caractéristiques techniques, ce produit permet de créer des angles de 45 degrés sans laisser apparaître les éléments de verrouillage de l'onglet.

Mosquiteira de correr

mosquiteira corredera / mosquito net sliding system
système de moustiquaire coulissante

C
04



índice

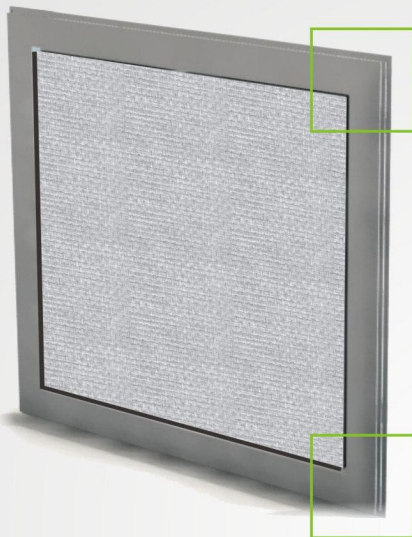

esquadros em poliamida
escuadras en poliamida
brackets polyamide
supports polyamide



esquadro com rolamento
escuadra con rodamiento
joint corners with bearing
équerre avec palier

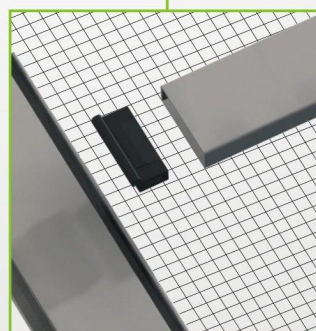

aplicação de travessa para alturas/larguras superiores a 1600mm
aplicación de llarguero para alturas / anchuras superiores a 1600mm
application of the crossbar for height / width greater than 1600m
application de la barre transversale pour la hauteur / largeur supérieur à 1600m

Mosquiteira fixa

mosquiteira fija / fixed system of mosquito net
moustiquaire fixe

C
05

índice



O artigo tem como função criar uma barreira contra os insetos, onde é aplicado de forma imóvel.

O artigo, devido às suas características técnicas, permite criar ângulos de 45° sem visualização dos componentes do fecho da esquadria.

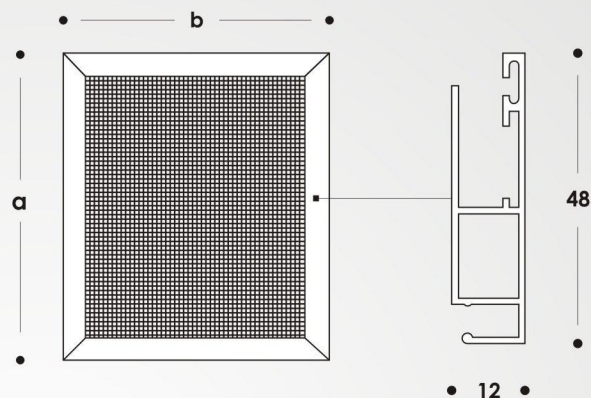

COR color / colour / couleur

Bruto *crudo / raw / brut*

Lacados outros Rall *lacado de otros colores rall / other lacquered colours rall / laqué autres couleurs rall*

Acetinado outros *otros satinado / other satins / autres satins*

		b (mm)							
		250-800	801-1000	1001-1200	1201-1400	1401-1600	1601-1800	1801-2000	2001-2100
a (mm)	250-1000	NIMF 01	NIMF 02	NIMF 03	NIMF 04	NIMF 05	NIMF 06	NIMF 07	NIMF 08
	1001-1200	NIMF 09	NIMF 10	NIMF 11	NIMF 12	NIMF 13	NIMF 14	NIMF 15	NIMF 16
	1201-1450	NIMF 17	NIMF 18	NIMF 19	NIMF 20	NIMF 21	NIMF 22	NIMF 23	NIMF 24
	1451-1600	NIMF 25	NIMF 26	NIMF 27	NIMF 28	NIMF 29	NIMF 30	NIMF 31	NIMF 32
	1601-1800	NIMF 33	NIMF 34	NIMF 35	NIMF 36	NIMF 37	-	-	-
	1801-2000	NIMF 41	NIMF 42	NIMF 43	NIMF 44	NIMF 45	-	-	-
	2001-2200	NIMF 49	NIMF 50	NIMF 51	NIMF 52	NIMF 53	-	-	-
	2201-2400	NIMF 57	NIMF 58	NIMF 59	NIMF 60	NIMF 61	-	-	-



El artículo tiene la función de crear una barrera contra los insectos, donde este se aplica de forma fija.

El artículo, debido a sus características técnicas, permite crear ángulos de 45° sin la visualización de los componentes de cierre de la esquadra.



The article has the function of creating a barrier against insects where it is fixed.

The article, due to its technical features, allows creating 45° angles without visualization of the components of the closure frame.



Ce produit fixe a pour fonction de créer une barrière contre les insectes.

De part ses caractéristiques techniques, ce produit permet de créer des angles de 45 degrés sans laisser apparaître les éléments de verrouillage de l'onglet.

Mosquiteira fixa

mosquiteira fija / fixed system of mosquito net
moustiquaire fixe



índice

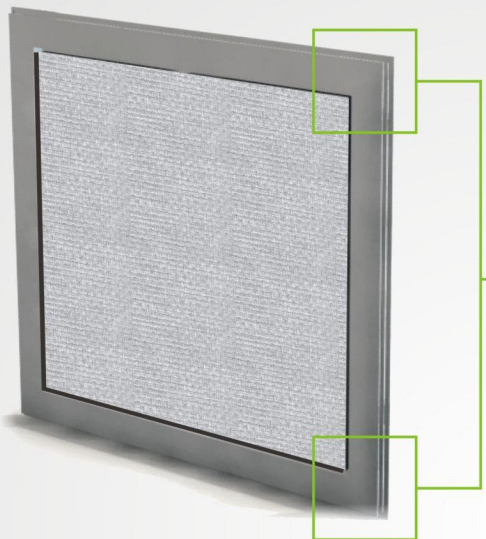

esquadros em poliamida
escuadras en poliamida
brackets polyamide
supports polyamide

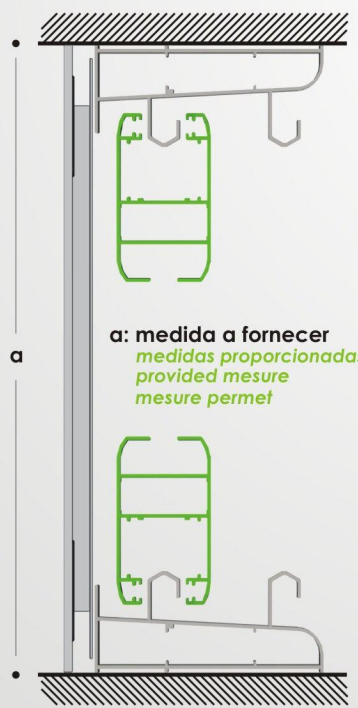

a: medida a fornecer
medidas proporcionadas
provided mesure
mesure permet

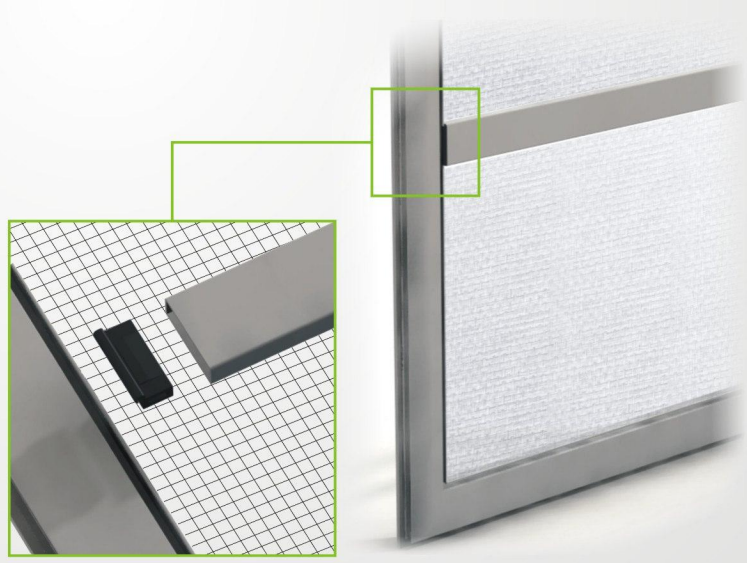

aplicação de travessa para alturas/larguras superiores a 1600mm
aplicación de llarguero para alturas / anchuras superiores a 1600mm
application of the crossbar for height / width greater than 1600m
application de la barre transversale pour la hauteur / largeur supérieur à 1600m

Sistema de mosquiteira horizontal "Harmónio"

sistema mosquiteira horizontal "Harmónio" / horizontal mosquito netting system "Harmónio"
système de moustiquaire à houlement horizontal "Harmónio"

C
07

índice



Este artigo tem como função criar uma barreira contra os insetos e em simultâneo proporcionar a abertura do mesmo na posição horizontal. Este sistema possui também a possibilidade de criar vãos de grande dimensão, pela capacidade de agrupar várias folhas. Acesso facilitado a portadores de deficiências motoras.

Aplicação: externa/interna da caixilharia de alumínio.



COR color / colour / couleur

Bruto *crudo / raw / brut*

Lacados outros Rall *lacado de outros colores rall / other lacquered colours rall / laqué autres couleurs rall*

Acetinados outros *otros satinado / other satins / autres satins*

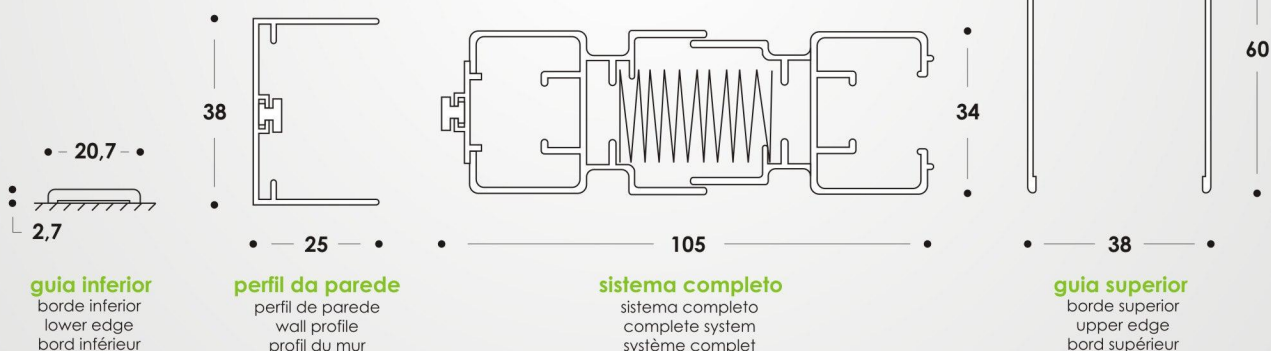

El sistema tiene la función de crear una barrera contra insectos y de proporcionar simultáneamente la abertura del mismo en posición horizontal para la desaparición de esto o para un acceso exterior del hogar. Fácil acceso a personas con discapacidad.

Aplicación: marco de aluminio interno y externo.



The system has the function of creating a barrier against insects and it simultaneously provides the same opening in the horizontal position to the disappearance of or access to the exterior of the house. Easy access to people with disabilities.

Application: internal/external aluminium frame.



Ce produit a pour fonction de créer une barrière contre les insectes. Ce système permet également une ouverture en position verticale afin de le rendre invisible et de faciliter l'accès à l'extérieur de la maison. Accès facile pour les personnes handicapées.

Application: Interne/externe de la fenêtre en

Sistema de mosquiteira horizontal "Harmónio"

sistema mosquiteira horizontal "Harmónio" / horizontal mosquito netting system "Harmónio"
système de moustiquaire à houlement horizontal "Harmónio"

C
08



índice



altura *altura / height / hauteur*

min.: 800mm max.: 2400mm

*largura por folha *ancho / width / largeur*

min.: 500mm max.: 1400mm

***proporção da folha:** largura= altura-300

proporción de la hoja: anchura = altura - 300

foil ratio: width = height - 300

proportion de la feuille: largeur = hauteur - 300

opções de abertura *opciones de abertura / opening options / options d'ouverture*

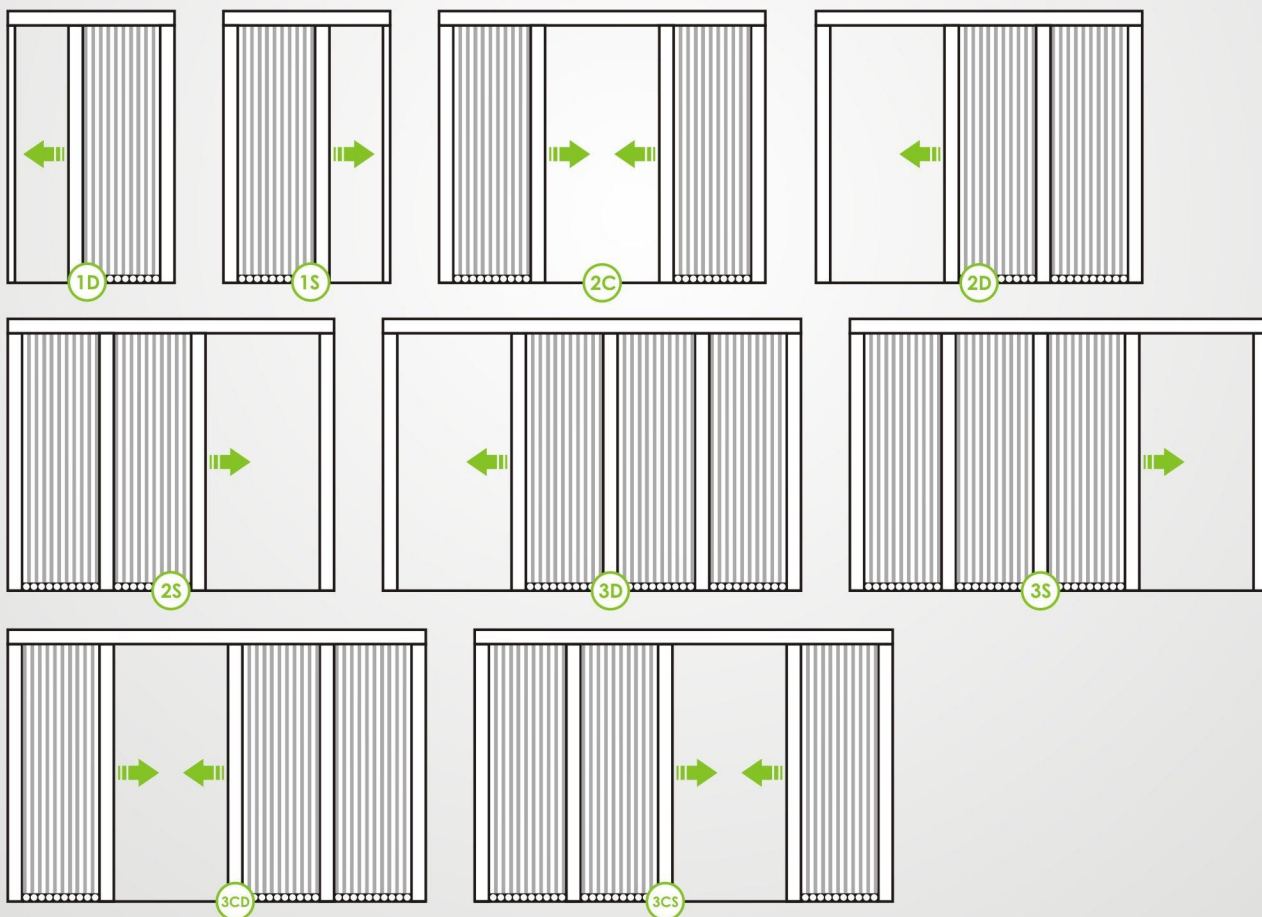

Sistema de hosquiteira horizontal "Rollout"

sistema mosquiteira horizontal "Rollout" / horizontal mosquito netting system "Rollout"
système de moustiquaire à roulement horizontal "Rollout"

C
09

índice



Este artigo tem como função criar uma barreira contra os insetos e em simultâneo proporcionar a abertura do mesmo na posição horizontal. Este sistema está limitado a vãos com a largura máxima de 2,80 metros. Acesso facilitado a portadores de deficiências motoras.

Aplicação: externa/interna da caixilharia de alumínio.



COR color / colour / couleur

Bruto *crudo / raw / brut*

Lacados outros Rall *lacado de otros colores rall / other lacquered colours rall / laqué autres couleurs rall*

Acetinados outros *otros satinado / other satins / autres satins*

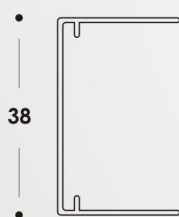

perfil da parede
perfil de parede
wall profile
profil du mur

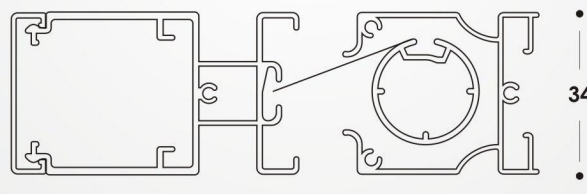

sistema completo
sistema completo
complete system
système complet

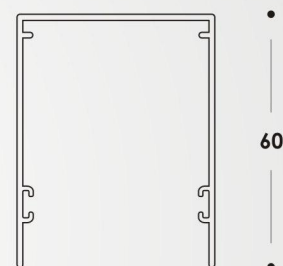

guia superior
borde superior
upper edge
bord supérieur

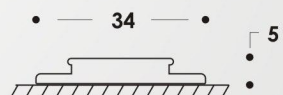

guia inferior
borde inferior
lower edge
bord inférieur



El sistema tiene la función de crear una barrera contra insectos y de proporcionar simultáneamente la abertura del mismo en posición horizontal para la desaparición de esto o para un acceso exterior del hogar. Fácil acceso a personas con discapacidad.

Aplicación: marco de aluminio interno y externo.



The system has the function of creating a barrier against insects and it simultaneously provides the same opening in the horizontal position to the disappearance of or access to the exterior of the house. Easy access to people with disabilities.

Application: internal/external aluminium frame.



Ce produit a pour fonction de créer une barrière contre les insectes. Ce système permet également une ouverture en position verticale afin de le rendre invisible et de faciliter l'accès à l'extérieur de la maison. Accès facile pour les personnes handicapées.

Application: Interne/externe de la fenêtre en

Sistema de hosquiteira horizontal "Rollout"

sistema mosquiteira horizontal "Rollout" / horizontal mosquito netting system "Rollout"
système de moustiquaire à roulement horizontal "Rollout"

C
10



índice



altura altura / height / hauteur

min.: 800mm max.: 2400mm

*largura por folha ancho / leaf / largeur

min.: 500mm max.: 1400mm

***proporção da folha:** largura = altura - 300

proporción de la hoja: anchura = altura - 300

foil ratio: width = height - 300

proportion de la feuille: largeur = hauteur - 300

opções de abertura opciones de abertura / opening options / options d'ouverture

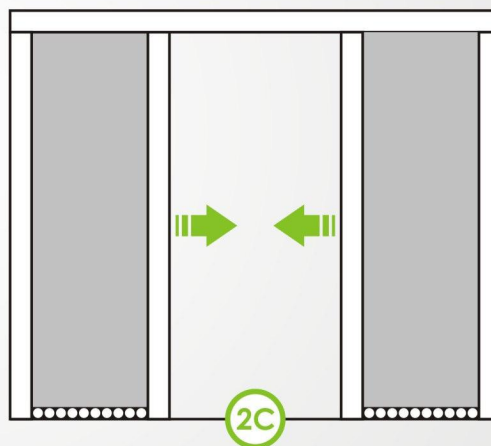
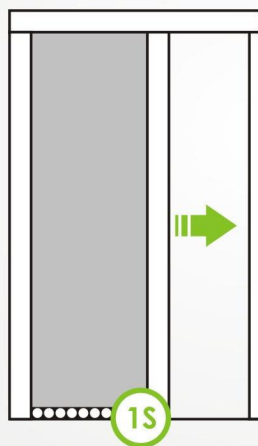
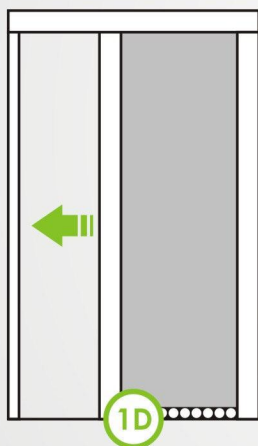

largura máxima com 2 Folhas: 2,80m

anchura máxima con 2 hojas: 2,80m

maximum width with 2 foil: 2,80m

largeur maximale avec deux feuilles: 2,80m

Rolos de rede mosquiteira (anti-fogo)

tela mosquiteira (antifuego) / mosquito net (fireproof)
ouleau moustiquaire (anti-feu)

C
11

índice



O artigo rolo de rede mosquiteira foi desenvolvido para aplicação interna/externa da caixilharia. O mesmo permite uma barreira eficaz contra insetos, proporcionando simultaneamente uma ventilação desse mesmo espaço.



ref.

a

b

NI3001	0,6	30
NI3002	0,8	
NI3003	1,0	
NI3004	1,2	
NI3005	1,5	
NI3006	1,6	

dimensões em metros

dimensiones en metros / dimensions in meters / dimensions en mètres

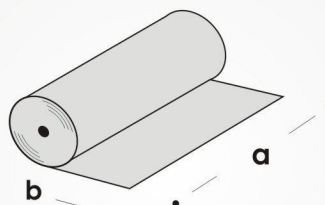

embalagem - NI3001

embalaje / packing / emballage

2,5kg



embalagem - NI3002

embalaje / packing / emballage

3,1kg



embalagem - NI3003

embalaje / packing / emballage

3,8kg



embalagem - NI3004

embalaje / packing / emballage

5,5kg



embalagem - NI3005

embalaje / packing / emballage

6,5kg



embalagem - NI3006

embalaje / packing / emballage

7,5kg



La tela mosquiteira fue desarrollado para aplicación interna y externa de los marcos de las ventanas. Permite una barrera eficaz contra insectos, proporcionando al mismo tiempo la circulación del aire de ese espacio.



The mosquito net was developed for internal / external application in the frames. It allows an effective barrier against insects, while it also provides ventilation in that area.



Ce rouleau de moustiquaire a été créé pour une application aussi bien interne qu'externe au châssis. Il constitue une barrière efficace contre les insectes et permet la ventilation de l'espace.