

AT01

ACTUEL

CARACTÉRISTIQUES
Features / Eigenschaften



TRAVERSE RENFORCÉE POUR MOTORISATION
REINFORCED PROFILE FOR MOTORIZATION
VERSTÄRKTE PROFIL FÜR MOTOREINBAU



LAME 200mm
BLADE 200mm
LAMELLE 200mm

POSSIBILITÉS
Options / Optionen



SUR MESURE
BESPOKE
MAßANFERTIGUNG



COULISSANT 2 VANTAUX
2 LEAVES SLIDING GATE
ZWEI FLÜGEL SCHIEBETOR



Portail Battant / Swing gate / Doppeltor
AT01

Portillon / Pedestrian Gate / Einzeltor
AT01

Portail Coulissant / Sliding Gate / Schiebetor
AT01

OPTIONS REPLISSAGE
Infill Options / Fülloptionen



Portail Battant et Coulissant
Swinging and Sliding Gates / Doppeltor und Schiebetor

DIMENSIONS
Dimensions / Maße
Largeur / Width / Breite (Minimum 2500mm / Maximum 5000mm)
Hauteur / Height / Höhe (Minimum 1000mm / Maximum 2200mm)

Portillon
Pedestrian Gate / Einzeltor

Largeur / Width / Breite (Minimum 800mm / Maximum 1500mm)
Hauteur / Height / Höhe (Minimum 1000mm / Maximum 2200mm)



CARACTÉRISTIQUES
Features / Eigenschaften



**TRAVERSE RENFORCÉE
POUR MOTORISATION**
REINFORCED PROFIL FOR MOTORIZATION
VERSTÄRKT PROFIL FÜR MOTOREINBAU



LAME 284mm
BLADE 284mm
LAMELLE 284mm

POSSIBILITÉS
Options / Optionen



SUR MESURE
BESPOKE
MAßANFERTIGUNG



COULISSANT 2 VANTAUX
2 LEAVES SLIDING GATE
ZWEI FLÜGEL SCHIEBETOR



Clôture / Fence / Zaun
AG29

Portail Battant / Swing gate / Doppeltor
AT02

Portillon / Pedestrian Gate / Einzeltor
AT02

Portail Coulissant / Sliding Gate / Schiebetor
AT02

OPTIONS REMPLISSAGE
Infill Options / Fülloptionen



Portail Battant et Coulissant
Swinging and Sliding Gates / Doppeltor und Schiebetor

DIMENSIONS
Dimensions / Maße
Largeur / Width / Breite (Minimum 2500mm / Maximum 5000mm)
Hauteur / Height / Höhe (Minimum 1000mm / Maximum 2200mm)

Portillon
Pedestrian Gate / Einzeltor

Largeur / Width / Breite (Minimum 800mm / Maximum 1500mm)
Hauteur / Height / Höhe (Minimum 1000mm / Maximum 2200mm)

AT03

ACTUEL



CARACTÉRISTIQUES
Features / Eigenschaften



TRAVERSE RENFORCÉE POUR MOTORISATION
REINFORCED PROFILE FOR MOTORIZATION
VERSTÄRKTEN PROFIL FÜR MOTOREINBAU



LAME 200mm
BLADE 200mm
LAMELLE 200mm



PROFIL DÉCOR 15mm
DECORATIVE PROFILE 15mm
DEKORATIV PROFIL 15mm

POSSIBILITÉS
Options / Optionen



SUR MESURE
BESPOKE
MAßANFERTIGUNG



COULISSANT 2 VANTAUX
2 LEAVES SLIDING GATE
ZWEI FLÜGEL SCHIEBETOR



Portail Battant / Swing Gate / Doppeltor
AT03

Portillon / Pedestrian Gate / Einzeltor
AT03

Portail Coulissant / Sliding Gate / Schiebetor
AT03



Portail Battant et Coulissant
Swinging and Sliding Gates / Doppeltor und Schiebetor

DIMENSIONS
Dimensions / Maße
Largeur / Width / Breite (Minimum 2500mm / Maximum 5000mm)
Hauteur / Height / Höhe (Minimum 1530mm / Maximum 2200mm)

Portillon
Pedestrian Gate / Einzeltor

Largeur / Width / Breite (Minimum 800mm / Maximum 1500mm)
Hauteur / Height / Höhe (Minimum 1530mm / Maximum 2200mm)



CARACTÉRISTIQUES
Features / Eigenschaften



TRAVERSE RENFORCÉE POUR MOTORISATION
REINFORCED TRAVERSE FOR MOTORIZATION
VERSTÄRKTE PROFIL FÜR MOTOREINBAU



LAME 200mm
BLADE 200mm
LAMELLE 200mm



PROFIL DÉCOR 15mm
DECORATIVE PROFILE 15mm
DEKORATIV PROFIL 15mm

POSSIBILITÉS
Options / Optionen



SUR MESURE
BESPOKE
MAßANFERTIGUNG



COULISSANT 2 VANTAUX
2 LEAVES SLIDING GATE
ZWEI FLÜGEL SCHIEBETOR



Portail Battant / Swing Gate / Doppeltor
AT04

Portillon / Pedestrian Gate / Einzeltor
AT04

Portail Coulissant / Sliding Gate / Schiebetor
AT04



Portail Battant et Coulissant
Swinging and Sliding Gates / Doppeltor und Schiebetor

DIMENSIONS
Dimensions / Maße
Largeur / Width / Breite (Minimum 2500mm / Maximum 5000mm)
Hauteur / Height / Höhe (Minimum 1730mm / Maximum 2200mm)

Portillon
Pedestrian Gate / Einzeltor

Largeur / Width / Breite (Minimum 800mm / Maximum 1500mm)
Hauteur / Height / Höhe (Minimum 1730mm / Maximum 2200mm)

AT05

AT06

CARACTÉRISTIQUES
Features / Eigenschaften



TRAVERSE RENFORCÉE POUR MOTORISATION
REINFORCED PROFILE FOR MOTORIZATION
VERSTÄRKTEN PROFIL FÜR MOTOREINBAU



LAME 200mm
BLADE 200mm
LAMELLE 200mm



PROFIL DÉCOR 15mm
DECORATIVE PROFILE 15mm
DEKORATIV PROFIL 15mm

POSSIBILITÉS
Options / Optionen



SUR MESURE
BESPOKE
MAßANFERTIGUNG



COULISSANT 2 VANTAUX
2 LEAVES SLIDING GATE
ZWEI FLÜGEL SCHIEBETOR



Portail Battant / Swing Gate / Doppeltor
AT05

Portillon / Pedestrian Gate / Einzeltor
AT05

Portail Coulissant / Sliding Gate / Schiebetor
AT05

Clôture / Fence / Zaun
AG33



Portail Battant / Swing Gate / Doppeltor
AT06

Portillon / Pedestrian Gate / Einzeltor
AT06

Portail Coulissant / Sliding Gate / Schiebetor
AT06

Clôture / Fence / Zaun
AG48

Portail Battant et Coulissant
Swinging and Sliding Gates / Doppeltor und Schiebetor

DIMENSIONS
Dimensions / Maße
Largeur / Width / Breite (Minimum 2500mm / Maximum 5000mm)
Hauteur / Height / Höhe (Minimum 1000mm / Maximum 2200mm)

Portillon
Pedestrian Gate / Einzeltor

Largeur / Width / Breite (Minimum 800mm / Maximum 1500mm)
Hauteur / Height / Höhe (Minimum 1000mm / Maximum 2200mm)

AT07

AT08



CARACTÉRISTIQUES
Features / Eigenschaften



TRAVERSE RENFORCÉE POUR MOTORISATION
REINFORCED PROFILE FOR MOTORIZATION
VERSTÄRKTE PROFIL FÜR MOTOREINBAU



LAME 200mm
BLADE 200mm
LAMELLE 200mm



PROFIL DÉCOR 15mm
DECORATIVE PROFILE 15mm
DEKORATIV PROFIL 15mm

POSSIBILITÉS
Options / Optionen



SUR MESURE
BESPOKE
MAßANFERTIGUNG



COULISSANT 2 VANTAUX
2 LEAVES SLIDING GATE
ZWEI FLÜGEL SCHIEBETOR



Portail Battant / Swing Gate / Doppeltor
AT07

Portillon / Pedestrian Gate / Einzeltor
AT07

Portail Coulissant / Sliding Gate / Schiebetor
AT07

Clôture / Fence / Zaun
AG32



Portail Battant / Swing Gate / Doppeltor
AT08

Portillon / Pedestrian Gate / Einzeltor
AT08
Clôture / Fence / Zaun
AG31
Portail Coulissant / Sliding Gate / Schiebetor
AT08



Portail Battant et Coulissant
Swinging and Sliding Gates / Doppeltor und Schiebetor

DIMENSIONS
Dimensions / Maße
Largeur / Width / Breite (Minimum 2500mm / Maximum 5000mm)
Hauteur / Height / Höhe (Minimum 1000mm / Maximum 2200mm)

Portillon
Pedestrian Gate / Einzeltor

Largeur / Width / Breite (Minimum 800mm / Maximum 1500mm)
Hauteur / Height / Höhe (Minimum 1000mm / Maximum 2200mm)

AT09

AT10



CARACTÉRISTIQUES
Features / Eigenschaften



TRAVERSE RENFORCÉE POUR MOTORISATION
REINFORCED PROFILE FOR MOTORIZATION
VERSTÄRKTE PROFIL FÜR MOTORENBÄU



LAME 200mm
BLADE 200mm
LAMELLE 200mm



PROFIL DÉCOR 15mm et 100mm
DECORATIVE PROFILE 15mm and 100mm
DEKORATIV PROFIL 15mm und 100mm

POSSIBILITÉS
Options / Optionen



SUR MESURE
BESPOKE
MAßANFERTIGUNG



COULISSANT 2 VANTAUX
2 LEAVES SLIDING GATE
ZWEI FLÜGEL SCHIEBETOR

ACTUEL



Portail Battant / Swing Gate / Doppeltor
AT09

Portillon / Pedestrian Gate / Einzeltor
AT09

Portail Coulissant / Sliding Gate / Schiebetor
AT09



Portail Battant / Swing Gate / Doppeltor
AT10

Portillon / Pedestrian Gate / Einzeltor
AT10

Portail Coulissant / Sliding Gate / Schiebetor
AT10

Portail Battant et Coulissant
Swinging and Sliding Gates / Doppeltor und Schiebetor

DIMENSIONS
Dimensions / Maße
Largeur / Width / Breite (Minimum 2500mm / Maximum 5000mm)
Hauteur / Height / Höhe (Minimum 1000mm / Maximum 2200mm)

Portillon
Pedestrian Gate / Einzeltor

Largeur / Width / Breite (Minimum 800mm / Maximum 1500mm)
Hauteur / Height / Höhe (Minimum 1000mm / Maximum 2200mm)

AT11

AT12

AT13



CARACTÉRISTIQUES
Features / Eigenschaften



TRAVERSE RENFORCÉE POUR MOTORISATION
REINFORCED PROFIL FOR MOTORIZATION
VERSTÄRKTE PROFIL FÜR MOTOREINBAU



LAME 200mm
BLADE 200mm
LAMELLE 200mm



VITRAGE SABLÉ
FROSTED GLASS
MILCHGLAS

POSSIBILITÉS
Options / Optionen



SUR MESURE
BESPOKE
MAßANFERTIGUNG



COULISSANT 2 VANTAUX
2 LEAVES SLIDING GATE
ZWEI FLÜGEL SCHIEBETOR



Portail Battant / Swing Gate / Doppeltor
AT11

Portillon / Pedestrian Gate / Einzeltor
AT11

Portail Couissant / Sliding Gate / Schiebetor
AT11



Portail Battant / Swing Gate / Doppeltor
AT12

Portillon / Pedestrian Gate / Einzeltor
AT12

Portail Couissant / Sliding Gate / Schiebetor
AT12



Portail Battant / Swing Gate / Doppeltor
AT13

Portillon / Pedestrian Gate / Einzeltor
AT13

Portail Couissant / Sliding Gate / Schiebetor
AT13

Portail Battant et Couissant
Swinging and Sliding Gates / Doppeltor und Schiebetor

DIMENSIONS
Dimensions / Maße
Largeur / Width / Breite (Minimum 2500mm / Maximum 5000mm)
Hauteur / Height / Höhe (Minimum 1000mm / Maximum 2200mm)

Portillon
Pedestrian Gate / Einzeltor

Largeur / Width / Breite (Minimum 800mm / Maximum 1500mm)
Hauteur / Height / Höhe (Minimum 1000mm / Maximum 2200mm)

AT14

AT15



ACTUEL

CARACTÉRISTIQUES
Features / Eigenschaften



TRAVERSE RENFORCÉE POUR MOTORISATION
REINFORCED TRAVERSE FOR MOTORIZATION
VERSTÄRKTE PROFIL FÜR MOTOREINBAU



LAME 200mm
BLADE 200mm
LAMELLE 200mm



TÔLE PERFORÉE
PERFORATED ALUMINUM SHEET
PERFORIERTES ALUMINIUMBLATT

POSSIBILITÉS
Options / Optionen



SUR MESURE
BESPOKE
MAßANFERTIGUNG



COULISSANT 2 VANTAUX
2 LEAVES SLIDING GATE
ZWEI FLÜGEL SCHIEBETOR

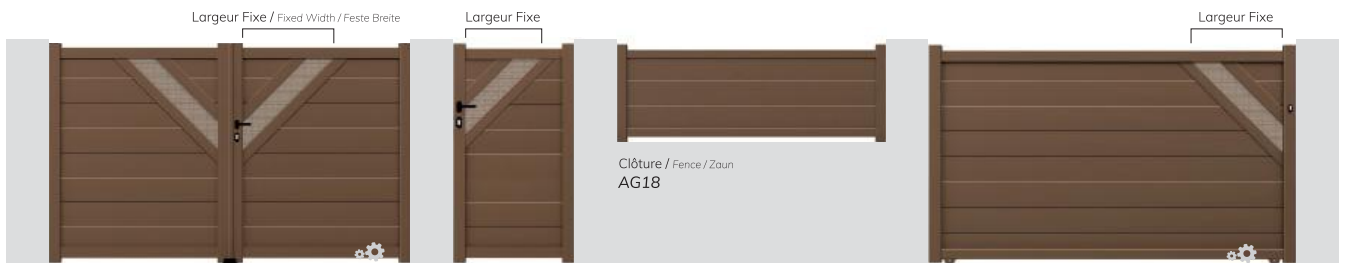

Portail Battant / Swing Gate / Doppeltor
AT14

Portillon / Pedestrian Gate / Einzeltor
AT14

Portail Couissant / Sliding Gate / Schiebetor
AT14

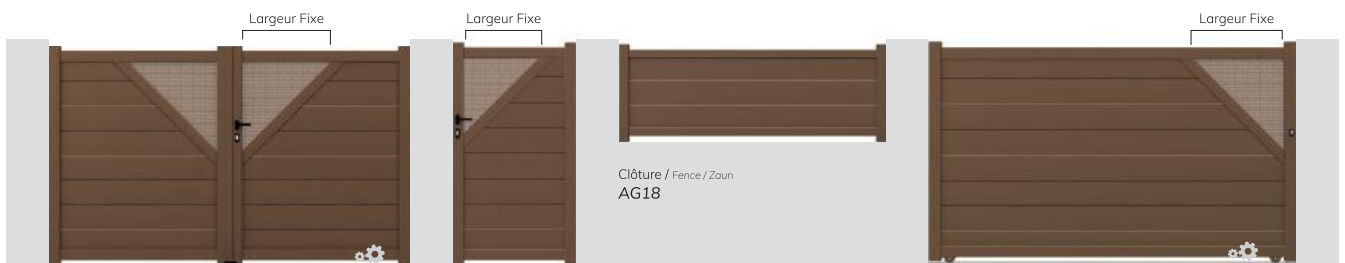

Portail Battant / Swing Gate / Doppeltor
AT15

Portillon / Pedestrian Gate / Einzeltor
AT15

Portail Couissant / Sliding Gate / Schiebetor
AT15

TÔLE PERFORÉE
Perforated Aluminum Sheet / Perforiertes Aluminiumblatt



Portail Battant et Couissant
Swinging and Sliding Gates / Doppeltor und Schiebetor

DIMENSIONS
Dimensions / Maße
Largeur / Width / Breite (Minimum 2500mm / Maximum 5000mm)
Hauteur / Height / Höhe (Minimum 1000mm / Maximum 2200mm)

Portillon
Pedestrian Gate / Einzeltor

Largeur / Width / Breite (Minimum 1000mm / Maximum 1500mm)
Hauteur / Height / Höhe (Minimum 1000mm / Maximum 2200mm)



CARACTÉRISTIQUES
Features / Eigenschaften



TRAVERSE RENFORCÉE POUR MOTORISATION
REINFORCED PROFIL FOR MOTORIZATION
VERSTÄRKTES PROFIL FÜR MOTOREINBAU



LAME 200mm
BLADE 200mm
LAMELLE 200mm



TÔLE PERFORÉE
PERFORATED ALUMINIUM SHEET
PERFORIERTES ALUMINIUMBLATT

POSSIBILITÉS
Options / Optionen



SUR MESURE
BESPOKE
MAßANFERTIGUNG



COULISSANT 2 VANTAUX
2 LEAVES SLIDING GATE
ZWEI FLÜGEL SCHIEBETOR

Hauteur Fixe /
Fixed Height / Feste Höhe



Portail Battant / Swing Gate / Doppeltor
AT16

Portillon / Pedestrian Gate / Einzeltor
AT16

Portail Coulissant / Sliding Gate / Schiebetor
AT16

Clôture / Fence / Zaun
AG18



TÔLE PERFORÉE AVEC COLORIS

PERFORATED ALUMINIUM SHEET WITH COLOUR
PERFORIERTES ALUMINIUMBLATT MIT FARBE

RAL 3004 STR
STANDARD

Autres couleurs disponibles / Other colours available /
Andere Farben erhältlich

CHOIX TÔLE PERFORÉE
Choose Perforated Aluminium Sheet / Wählen
Perforiertes Aluminiumblatt



Portail Battant et Coulissant
Swinging and Sliding Gates / Doppeltor und Schiebetor

DIMENSIONS
Dimensions / Maße
Largeur / Width / Breite (Minimum 2500mm / Maximum 4000mm)
Hauteur / Height / Höhe (Minimum 1000mm / Maximum 2200mm)

Portillon
Pedestrian Gate / Einzeltor

Largeur / Width / Breite (Minimum 800mm / Maximum 1500mm)
Hauteur / Height / Höhe (Minimum 1000mm / Maximum 2200mm)

AT17P

AT19P



CARACTÉRISTIQUES
Features / Eigenschaften



TRAVERSE RENFORCÉE POUR MOTORISATION
REINFORCED PROFILE FOR MOTORIZATION
VERSTÄRKTES PROFIL FÜR MOTOREINBAU



LAME 200mm
BLADE 200mm
LAMELLE 200mm



TÔLE PERFORÉE
PERFORATED ALUMINUM SHEET
PERFORIERTES ALUMINIUMBLATT

POSSIBILITÉS
Options / Optionen



SUR MESURE
BESPOKE
MAßANFERTIGUNG



COULISSANT 2 VANTAUX
2 LEAVES SLIDING GATE
ZWEI FLÜGEL SCHIEBETOR



Portail Battant / Swing Gate / Doppeltor
AT17P

Portillon / Pedestrian Gate / Einzeltor
AT17P

Portail Coulissant / Sliding Gate / Schiebetor
AT17P

Portail Battant et Coulissant
Swinging and Sliding Gates / Doppeltor und Schiebetor

DIMENSIONS Largeur / Width / Breite (Minimum 2500mm / Maximum 5000mm)
Dimensions / Maße Hauteur / Height / Höhe (Minimum 1000mm / Maximum 2200mm)

Portillon
Pedestrian Gate / Einzeltor

Largeur / Width / Breite (Minimum 800mm / Maximum 1500mm)
Hauteur / Height / Höhe (Minimum 1000mm / Maximum 2200mm)



Portail Battant / Swing Gate / Doppeltor
AT19P

Portillon / Pedestrian Gate / Einzeltor
AT19P

Portail Coulissant / Sliding Gate / Schiebetor
AT19P

Portail Battant et Coulissant
Swinging and Sliding Gates / Doppeltor und Schiebetor

DIMENSIONS Largeur / Width / Breite (Minimum 2500mm / Maximum 4000mm)
Dimensions / Maße Hauteur / Height / Höhe (Minimum 1000mm / Maximum 2200mm)

Portillon
Pedestrian Gate / Einzeltor

Largeur / Width / Breite (Minimum 800mm / Maximum 1500mm)
Hauteur / Height / Höhe (Minimum 1000mm / Maximum 2200mm)

AT17P / AT19P:

CHOIX TÔLE PERFORÉE
Choose Perforated Aluminum Sheet / Wählen
Perforiertes Aluminiumblatt



OPTIONS REMPLISSAGE
Infill Options / Fülloptionen





AT17-02



CARACTÉRISTIQUES
Features / Eigenschaften



TRaverse RENFORCÉE POUR MOTORISATION
REINFORCED PROFILE FOR MOTORIZATION
VERSTÄRKTES PROFIL FÜR MOTORENBAU



LAME 200mm
BLADE 200mm
LAMELLE 200mm



TÔLE DÉCORATIVE
DECORATED ALUMINUM SHEET
DEKORATIV ALUMINIUMBLATT

POSSIBILITÉS
Options / Optionen



SUR MESURE
BESPOKE
MAßANFERTIGUNG



COULISSANT 2 VANTAUX
2 LEAVES SLIDING GATE
ZWEI FLÜGEL SCHIEBETOR

ACTUEL



Portail Battant / Swing Gate / Doppeltor
AT17-02

Portillon / Pedestrian Gate / Einzeltor
AT17-02

Portail Coulissant / Sliding Gate / Schiebetor
AT17-02



RAL 9006 STR

TÔLE DÉCORATIVE AVEC COLORIS
DECORATIVE SHEET WITH COLOUR
DEKORBLATT MIT FARBE

OPTIONS REMPLISSAGE
Infill Options / Fülloptionen



Portail Battant et Coulissant
Swinging and Sliding Gates / Doppeltor und Schiebetor

DIMENSIONS
Dimensions / Maße
Largeur / Width / Breite (Minimum 2500mm / Maximum 5000mm)
Hauteur / Height / Höhe (Minimum 1000mm / Maximum 2200mm)

Portillon
Pedestrian Gate / Einzeltor

Largeur / Width / Breite (Minimum 800mm / Maximum 1500mm)
Hauteur / Height / Höhe (Minimum 1000mm / Maximum 2200mm)



CARACTÉRISTIQUES
Features / Eigenschaften



TRAVERSE RENFORCÉE POUR MOTORISATION
REINFORCED PROFIL FOR MOTORIZATION
VERSTÄRKTE PROFIL FÜR MOTOREINBAU



LAME 200mm
BLADE 200mm
LAMELLE 200mm



TÔLE DÉCORATIVE
DECORATED ALUMINUM SHEET
DEKORATIV ALUMINIUMBLATT

POSSIBILITÉS
Options / Optionen



SUR MESURE
BESPOKE
MAßANFERTIGUNG



COULISSANT 2 VANTAUX
2 LEAVES SLIDING GATE
ZWEI FLÜGEL SCHIEBETOR



OPTIONS REMPLISSAGE
Infill Options / Fülloptionen



Portail Battant et Coulissant
Swinging and Sliding Gates / Doppeltor und Schiebtor

DIMENSIONS
Dimensions / Maße
Largeur / Width / Breite (Minimum 2500mm / Maximum 5000mm)
Hauteur / Height / Höhe (Minimum 1000mm / Maximum 2200mm)

Portillon
Pedestrian Gate / Einzeltor

Largeur / Width / Breite (Minimum 800mm / Maximum 1500mm)
Hauteur / Height / Höhe (Minimum 1000mm / Maximum 2200mm)

DÉCORS

Designs



Portail Battant • AT18-11

Portail Battant / Swing Gate / Doppeltor



Décors à l'intérieur /
Designs in the middle



Décors à l'extérieur /
Designs in the edges

Portillon / Pedestrian Gate / Einzeltor



Décors côté
serrure / Designs on
the side of the lock



Décors côté gond /
Designs on the opposite
side of the lock

Clôture / Fence / Zaun



Décors à gauche /
Designs to the left



Décors à droite /
Designs to the right

Portail Couissant / Sliding Gate / Schiebetor



Décors côté
serrure / Designs on
the side of the lock



Décors côté platine /
Designs on the opposite
side of the lock

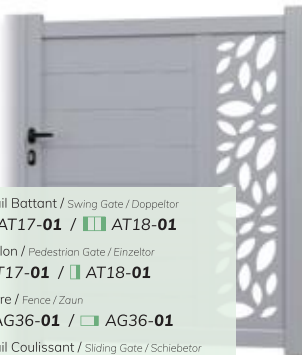

Portail Battant / Swing Gate / Doppeltor

AT17-01 / AT18-01

Portillon / Pedestrian Gate / Einzeltor

AT17-01 / AT18-01

Clôture / Fence / Zaun

AG36-01 / AG36-01

Portail Couissant / Sliding Gate / Schiebetor

AT17-01 / AT18-01

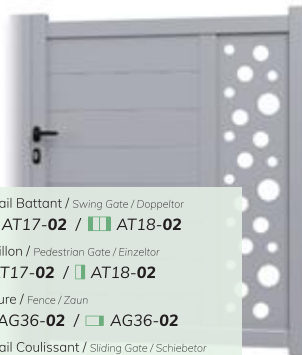

Portail Battant / Swing Gate / Doppeltor

AT17-02 / AT18-02

Portillon / Pedestrian Gate / Einzeltor

AT17-02 / AT18-02

Clôture / Fence / Zaun

AG36-02 / AG36-02

Portail Couissant / Sliding Gate / Schiebetor

AT17-02 / AT18-02

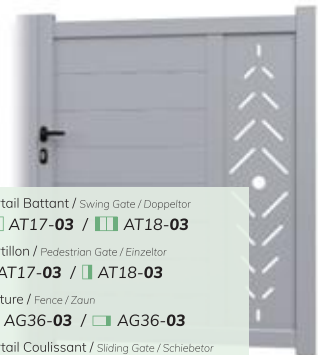

Portail Battant / Swing Gate / Doppeltor

AT17-03 / AT18-03

Portillon / Pedestrian Gate / Einzeltor

AT17-03 / AT18-03

Clôture / Fence / Zaun

AG36-03 / AG36-03

Portail Couissant / Sliding Gate / Schiebetor

AT17-03 / AT18-03

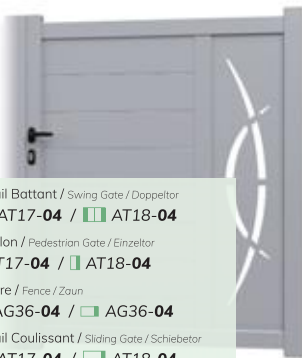

Portail Battant / Swing Gate / Doppeltor

AT17-04 / AT18-04

Portillon / Pedestrian Gate / Einzeltor

AT17-04 / AT18-04

Clôture / Fence / Zaun

AG36-04 / AG36-04

Portail Couissant / Sliding Gate / Schiebetor

AT17-04 / AT18-04

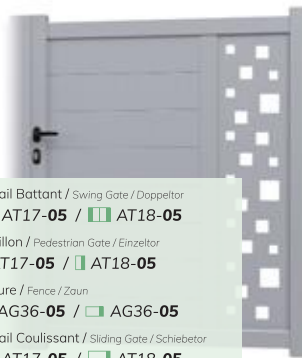

Portail Battant / Swing Gate / Doppeltor

AT17-05 / AT18-05

Portillon / Pedestrian Gate / Einzeltor

AT17-05 / AT18-05

Clôture / Fence / Zaun

AG36-05 / AG36-05

Portail Couissant / Sliding Gate / Schiebetor

AT17-05 / AT18-05

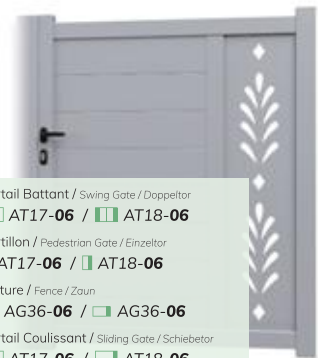

Portail Battant / Swing Gate / Doppeltor

AT17-06 / AT18-06

Portillon / Pedestrian Gate / Einzeltor

AT17-06 / AT18-06

Clôture / Fence / Zaun

AG36-06 / AG36-06

Portail Couissant / Sliding Gate / Schiebetor

AT17-06 / AT18-06

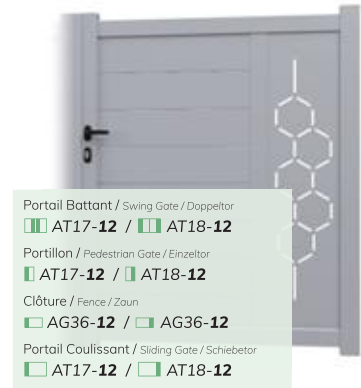
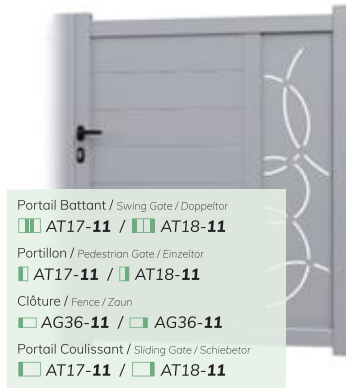
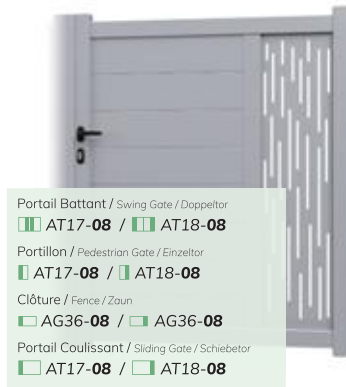

Portail Battant • AT17-06

AT19-05

AT20-08



ACTUEL

CARACTÉRISTIQUES
Features / Eigenschaften



TRAVERSE RENFORCÉE POUR MOTORISATION
REINFORCED PROFILE FOR MOTORIZATION
VERSTÄRKTE PROFIL FÜR MOTORENBAU



LAME 200mm
BLADE 200mm
LAMELLE 200mm



TÔLE DÉCORATIVE
DECORATED ALUMINUM SHEET
DEKORATIV ALUMINIUMBLATT

POSSIBILITÉS
Options / Optionen



SUR MESURE
BESPOKE
MAßANFERTIGUNG



COULISSANT 2 VANTAUX
2 LEAVES SLIDING GATE
ZWEI FLÜGEL SCHIEBETOR



Portail Battant / Swing Gate / Doppeltor
AT19-05

Portillon / Pedestrian Gate / Einzeltor
AT19-05

Portail Couissant / Sliding Gate / Schiebetor
AT19-05

AT19-XX:
OPTIONS REEMPLISSAGE
Infill Options / Fülloptionen



Portail Battant / Swing Gate / Doppeltor
AT20-08

Portillon / Pedestrian Gate / Einzeltor
AT20-08

Portail Couissant / Sliding Gate / Schiebetor
AT20-08

DIMENSIONS
Dimensions / Maße

Portail Battant et Couissant
Swinging and Sliding Gates / Doppeltor und Schiebetor

Largeur / Width / Breite (Minimum 2500mm / Maximum 5000mm)
Hauteur / Height / Höhe (Minimum 1000mm / Maximum 2200mm)

Portillon
Pedestrian Gate / Einzeltor

Largeur / Width / Breite (Minimum 800mm / Maximum 1500mm)
Hauteur / Height / Höhe (Minimum 1000mm / Maximum 2200mm)



DÉCORS

Designs

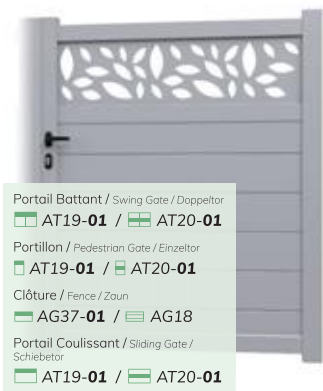

Portail Battant / Swing Gate / Doppeltor
 AT19-01 / AT20-01
 Portillon / Pedestrian Gate / Einzeltor
 AT19-01 / AT20-01
 Clôture / Fence / Zaun
 AG37-01 / AG18
 Portail Coulissant / Sliding Gate / Schiebtor
 AT19-01 / AT20-01

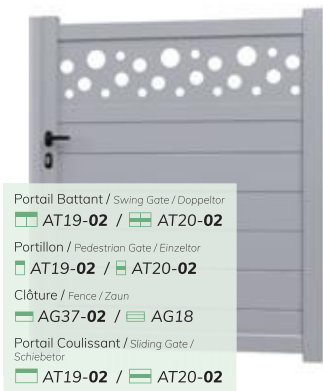

Portail Battant / Swing Gate / Doppeltor
 AT19-02 / AT20-02
 Portillon / Pedestrian Gate / Einzeltor
 AT19-02 / AT20-02
 Clôture / Fence / Zaun
 AG37-02 / AG18
 Portail Coulissant / Sliding Gate / Schiebtor
 AT19-02 / AT20-02

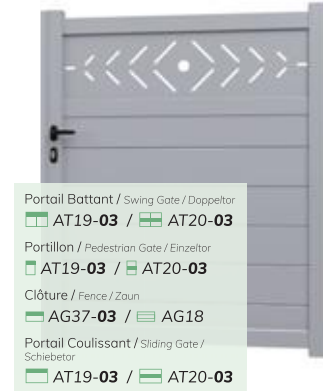

Portail Battant / Swing Gate / Doppeltor
 AT19-03 / AT20-03
 Portillon / Pedestrian Gate / Einzeltor
 AT19-03 / AT20-03
 Clôture / Fence / Zaun
 AG37-03 / AG18
 Portail Coulissant / Sliding Gate / Schiebtor
 AT19-03 / AT20-03

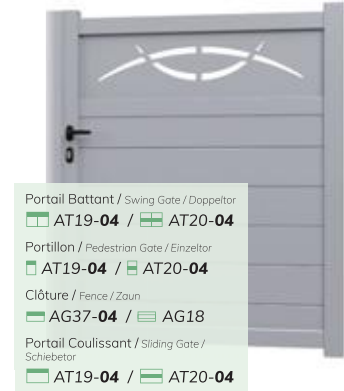

Portail Battant / Swing Gate / Doppeltor
 AT19-04 / AT20-04
 Portillon / Pedestrian Gate / Einzeltor
 AT19-04 / AT20-04
 Clôture / Fence / Zaun
 AG37-04 / AG18
 Portail Coulissant / Sliding Gate / Schiebtor
 AT19-04 / AT20-04

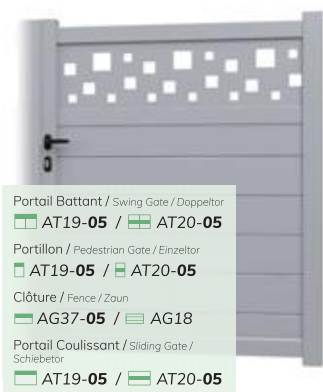

Portail Battant / Swing Gate / Doppeltor
 AT19-05 / AT20-05
 Portillon / Pedestrian Gate / Einzeltor
 AT19-05 / AT20-05
 Clôture / Fence / Zaun
 AG37-05 / AG18
 Portail Coulissant / Sliding Gate / Schiebtor
 AT19-05 / AT20-05

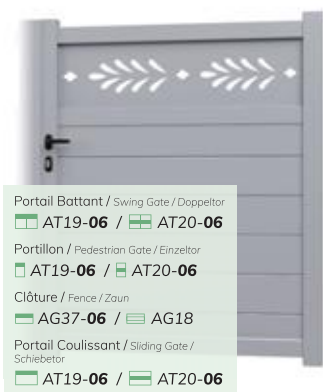

Portail Battant / Swing Gate / Doppeltor
 AT19-06 / AT20-06
 Portillon / Pedestrian Gate / Einzeltor
 AT19-06 / AT20-06
 Clôture / Fence / Zaun
 AG37-06 / AG18
 Portail Coulissant / Sliding Gate / Schiebtor
 AT19-06 / AT20-06

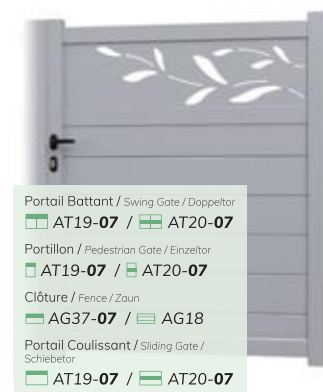

Portail Battant / Swing Gate / Doppeltor
 AT19-07 / AT20-07
 Portillon / Pedestrian Gate / Einzeltor
 AT19-07 / AT20-07
 Clôture / Fence / Zaun
 AG37-07 / AG18
 Portail Coulissant / Sliding Gate / Schiebtor
 AT19-07 / AT20-07



Portail Battant / Swing Gate / Doppeltor
 AT19-08 / AT20-08
 Portillon / Pedestrian Gate / Einzeltor
 AT19-08 / AT20-08
 Clôture / Fence / Zaun
 AG37-08 / AG18
 Portail Coulissant / Sliding Gate / Schiebtor
 AT19-08 / AT20-08

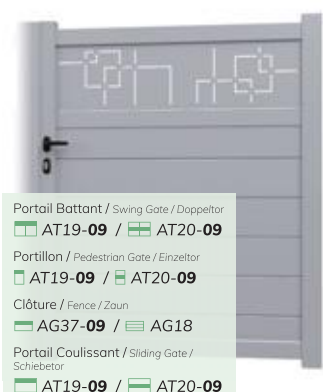

Portail Battant / Swing Gate / Doppeltor
 AT19-09 / AT20-09
 Portillon / Pedestrian Gate / Einzeltor
 AT19-09 / AT20-09
 Clôture / Fence / Zaun
 AG37-09 / AG18
 Portail Coulissant / Sliding Gate / Schiebtor
 AT19-09 / AT20-09

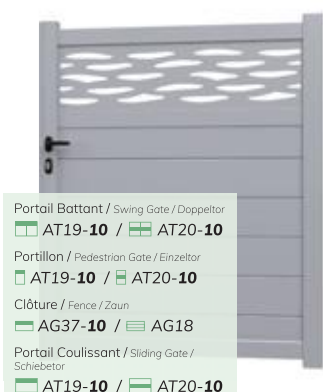

Portail Battant / Swing Gate / Doppeltor
 AT19-10 / AT20-10
 Portillon / Pedestrian Gate / Einzeltor
 AT19-10 / AT20-10
 Clôture / Fence / Zaun
 AG37-10 / AG18
 Portail Coulissant / Sliding Gate / Schiebtor
 AT19-10 / AT20-10

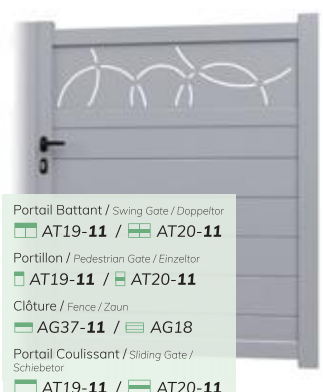

Portail Battant / Swing Gate / Doppeltor
 AT19-11 / AT20-11
 Portillon / Pedestrian Gate / Einzeltor
 AT19-11 / AT20-11
 Clôture / Fence / Zaun
 AG37-11 / AG18
 Portail Coulissant / Sliding Gate / Schiebtor
 AT19-11 / AT20-11

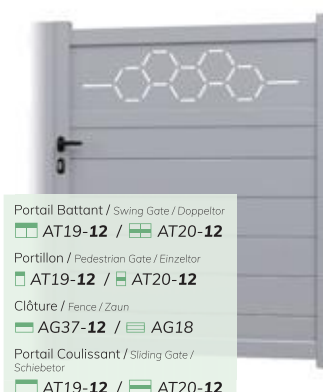

Portail Battant / Swing Gate / Doppeltor
 AT19-12 / AT20-12
 Portillon / Pedestrian Gate / Einzeltor
 AT19-12 / AT20-12
 Clôture / Fence / Zaun
 AG37-12 / AG18
 Portail Coulissant / Sliding Gate / Schiebtor
 AT19-12 / AT20-12





Portail Battant / Swing Gate / Doppeltor

 Décors supérieure / Designs on the top
 Décors au milieu / Designs in the middle

Portillon / Pedestrian Gate / Einzeltor

 Décors supérieure / Designs on the top
 Décors au milieu / Designs in the middle

Clôture / Fence / Zaun

 Décors supérieure / Designs on the top
 LAME 200mm (sans décors) / blade 200mm (without designs)

Portail Coulissant / Sliding Gate / Schiebtor

 Décors supérieure / Designs on the top
 Décors au milieu / Designs in the middle

ACTUEL

A white decorative fence with a gate, set against a modern house and lush greenery. The fence features horizontal slats and decorative posts with geometric patterns. A green circular callout highlights the text 'POTEAU DÉCORATIF' and 'DECORATIVE POST'.

**POTEAU
DÉCORATIF**
DECORATIVE POST

AT21

AT22

AT23

CARACTÉRISTIQUES
Features / Eigenschaften



TRAVERSE RENFORCÉE POUR MOTORISATION
REINFORCED PROFILE FOR MOTORIZATION
VERSTÄRKTE PROFIL FÜR MOTOREINBAU



LAME 100mm
BLADE 100mm
LAMELLE 100mm



TUBE VENTILÉE 64mm
VENTILATED TUBE 64mm
BELÜFTETE ROHR 64mm

POSSIBILITÉS
Options / Optionen



SUR MESURE
BESPOKE
MAßANFERTIGUNG



COULISSANT 2 VANTAUX
2 LEAVES SLIDING GATE
ZWEI FLÜGEL SCHIEBETOR



Portail Battant / Swing Gate / Doppeltor
AT21

Portillon / Pedestrian Gate / Einzeltor
AT21

Portail Couissant / Sliding Gate / Schiebetor
AT21

Clôture / Fence / Zaun
AG24



Portail Battant / Swing Gate / Doppeltor
AT22

Portillon / Pedestrian Gate / Einzeltor
AT22

Portail Couissant / Sliding Gate / Schiebetor
AT22

Clôture / Fence / Zaun
AG24



Portail Battant / Swing Gate / Doppeltor
AT23

Portillon / Pedestrian Gate / Einzeltor
AT23

Portail Couissant / Sliding Gate / Schiebetor
AT23

Clôture / Fence / Zaun
AG24



Portail Battant et Couissant
Swinging and Sliding Gates / Doppeltor und Schiebetor

DIMENSIONS
Dimensions / Maße

Largeur / Width / Breite (Minimum 2500mm / Maximum 4000mm)
Hauteur / Height / Höhe (Minimum 1000mm / Maximum 2200mm)

Portillon
Pedestrian Gate / Einzeltor

Largeur / Width / Breite (Minimum 800mm / Maximum 1500mm)
Hauteur / Height / Höhe (Minimum 1000mm / Maximum 2200mm)

AT24

ACTUEL

CARACTÉRISTIQUES
Features / Eigenschaften



TRaverse RENFORCÉE POUR MOTORISATION
REINFORCED PROFILE FOR MOTORIZATION
VERSTÄRKTES PROFIL FÜR MOTOREINBAU



TUBE VENTILÉE 140mm
VENTILATED TUBE 140mm
BELÜFTETES ROHR 140mm

POSSIBILITÉS
Options / Optionen



SUR MESURE
BESPOKE
MAßANFERTIGUNG



COULISSANT 2 VANTAUX
2 LEAVES SLIDING GATE
ZWEI FLÜGEL SCHIEBETOR



Portail Battant / Swing Gate / Doppeltor
AT24

Portillon / Pedestrian Gate / Einzeltor
AT24

Portail Coulissant / Sliding Gate / Schiebetor
AT24

Clôture / Fence / Zaun
AG40

Tableau des Dimensions Possibles

Dimensions Chart / Maße Tabelle

Portail Battant et Coulissant & Portillon AT24
Pedestrian, Sliding and Swing Gates
Einzeltor, Doppeltor und Schiebetor

Hauteur / Height / Höhe
[1042 | 1174 | 1306 | 1438 | 1570 | 1702 |
1834 | 1966 | 2098]

Clôture AG40
Fence / Zaun

Largeur / Width / Breite
[Minimum 430mm / Maximum 2070mm]

Hauteur / Height / Höhe
[584 | 716 | 848 | 980 | 1112 | 1244 | 1376 |
1508 | 1640 | 1772]



DIMENSIONS
Dimensions / Maße

Portail Battant et Coulissant
Swinging and Sliding Gates / Doppeltor und Schiebetor

Largeur / Width / Breite (Minimum 2500mm / Maximum 4000mm)

Portillon
Pedestrian Gate / Einzeltor

Largeur / Width / Breite (Minimum 800mm / Maximum 1500mm)



CARACTÉRISTIQUES
Features / Eigenschaften



**TRAVERSE RENFORCÉE
POUR MOTORISATION**
REINFORCED PROFIL FOR MOTORIZATION
VERSTÄRKTE PROFIL FÜR MOTOREINBAU



LAME ÉPINÉE 100mm
SPINED BLADE 100mm
WIRBELSÄULE LAMELLE 100mm

POSSIBILITÉS
Options / Optionen



SUR MESURE
BESPOKE
MAßANFERTIGUNG



COULISSANT 2 VANTAUX
2 LEAVES SLIDING GATE
ZWEI FLÜGEL SCHIEBETOR

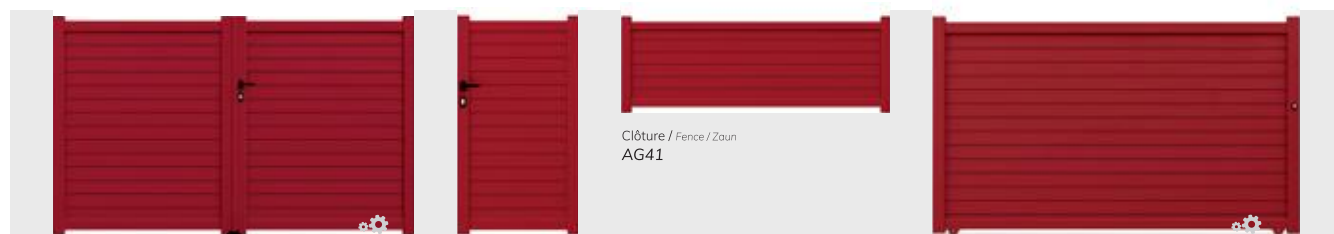

Clôture / Fence / Zaun
AG41

Portail Battant / Swing Gate / Doppeltor
AT25

Portillon / Pedestrian Gate / Einzeltor
AT25

Portail Coulissant / Sliding Gate / Schiebetor
AT25

Tableau des Dimensions Possibles

Dimensions Chart / Maße Tabelle

Portail Battant et Coulissant & Portillon AT25
Pedestrian, Sliding and Swing Gates
Einzeltor, Doppeltor und Schiebetor

Hauteur / Height / Höhe
[1028 | 1128 | 1228 | 1328 | 1428 | 1528 |
1628 | 1728 | 1828 | 1928]

Clôture AG41
Fence / Zaun

Largeur / Width / Breite
[Minimum 430mm / Maximum 2070mm]

Hauteur / Height / Höhe
[265 | 365 | 465 | 565 | 665 | 765 | 865 |
965 | 1065 | 1165 | 1265 | 1365 | 1465 |
1565 | 1665 | 1765 | 1865]



DIMENSIONS
Dimensions / Maße

Portail Battant et Coulissant
Swinging and Sliding Gates / Doppeltor und Schiebetor
Largeur / Width / Breite (Minimum 2500mm / Maximum 4000mm)

Portillon
Pedestrian Gate / Einzeltor
Largeur / Width / Breite (Minimum 800mm / Maximum 1500mm)



CARACTÉRISTIQUES
Features / Eigenschaften



TRAVERSE RENFORCÉE POUR MOTORISATION
REINFORCED PROFIL FOR MOTORIZATION
VERSTÄRKTES PROFIL FÜR MOTOREINBAU



LAME ONDULÉE 100mm
CORRUGATED BLADE 100mm
GEWELLT LAMELLE 100mm

POSSIBILITÉS
Options / Optionen



SUR MESURE
BESPOKE
MAßANFERTIGUNG



COULISSANT 2 VANTAUX
2 LEAVES SLIDING GATE
ZWEI FLÜGEL SCHIEBETOR



Portail Battant / Swing Gate / Doppeltor
AT26

Portillon / Pedestrian Gate / Einzeltor
AT26

Portail Coulissant / Sliding Gate / Schiebetor
AT26

Clôture / Fence / Zaun
AG42

Tableau des Dimensions Possibles

Dimensions Chart / Maße Tabelle

Portail Battant et Coulissant & Portillon AT26
Pedestrian, Sliding and Swing Gates
Einzeltor, Doppeltor und Schiebetor

Hauteur / Height / Höhe
[1018 | 1118 | 1218 | 1318 | 1418 | 1518 |
1618 | 1718 | 1818 | 1918]

Clôture AG42
Fence / Zaun

Largeur / Width / Breite
[Minimum 430mm / Maximum 2070mm]

Hauteur / Height / Höhe
[256 | 356 | 456 | 556 | 656 | 756 | 856 | 956
| 1056 | 1156 | 1256 | 1356 | 1456 | 1556
| 1656 | 1756]

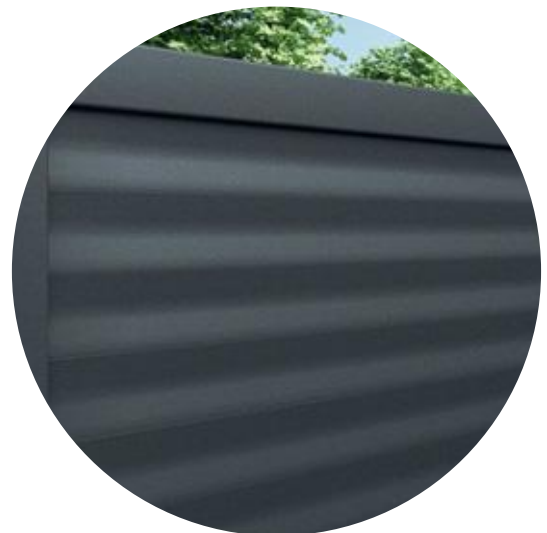

DIMENSIONS
Dimensions / Maße

Portail Battant et Coulissant
Swinging and Sliding Gates / Doppeltor und Schiebetor

Largeur / Width / Breite (Minimum 2500mm / Maximum 4000mm)

Portillon
Pedestrian Gate / Einzeltor

Largeur / Width / Breite (Minimum 800mm / Maximum 1500mm)



CARACTÉRISTIQUES
Features / Eigenschaften



**TRAVERSE RENFORCÉE
POUR MOTORISATION**
REINFORCED PROFIL FOR MOTORIZATION
VERSTÄRKT PROFIL FÜR MOTOREINBAU



LAME 200mm
BLADE 200mm
LAMELLE 200mm



LAME ONDULÉE 100mm
CORRUGATED BLADE 100mm
GEWELLT LAMELLE 100mm

POSSIBILITÉS
Options / Optionen



SUR MESURE
BESPOKE
MAßANFERTIGUNG



COULISSANT 2 VANTAUX
2 LEAVES SLIDING GATE
ZWEI FLÜGEL SCHIEBETOR



Clôture / Fence / Zaun
AG18

Portail Battant / Swing Gate / Doppeltor
AT27

Portillon / Pedestrian Gate / Einzeltor
AT27

Portail Coulissant / Sliding Gate / Schiebetor
AT27



Portail Battant et Coulissant
Swinging and Sliding Gates / Doppeltor und Schiebetor

DIMENSIONS
Dimensions / Maße
Largeur / Width / Breite (Minimum 2500mm / Maximum 4000mm)
Hauteur / Height / Höhe (Minimum 1000mm / Maximum 2200mm)

Portillon
Pedestrian Gate / Einzeltor

Largeur / Width / Breite (Minimum 800mm / Maximum 1500mm)
Hauteur / Height / Höhe (Minimum 1000mm / Maximum 2200mm)

AT28

AT29



CARACTÉRISTIQUES
Features / Eigenschaften



LAME RENFORCÉE POUR MOTORISATION
REINFORCED TRAVERSE FOR MOTORIZATION
VERSTÄRKTES PROFIL FÜR MOTOREINBAU



LAME 200mm et 284mm
BLADE 200mm and 284mm
LAMELLE 200mm und 284mm



LAME ONDULÉE 100mm
CORRUGATED BLADE 100mm
GEWELLT LAMELLE 100mm

POSSIBILITÉS
Options / Optionen



SUR MESURE
BESPOKE
MAßANFERTIGUNG



COULISSANT 2 VANTAUX
2 LEAVES SLIDING GATE
ZWEI FLÜGEL SCHIEBETOR

Hauteur Fixe /
Fixed Height / Feste Höhe



Portail Battant / Swing Gate / Doppeltor
AT28

Portillon / Pedestrian Gate / Einzeltor
AT28

Portail Coulissant / Sliding Gate / Schiebetor
AT28

Clôture / Fence / Zaun
AG18



Hauteur Fixe



Portail Battant / Swing Gate / Doppeltor
AT29

Portillon / Pedestrian Gate / Einzeltor
AT29

Portail Coulissant / Sliding Gate / Schiebetor
AT29

Clôture / Fence / Zaun
AG18



PROFIL DÉCOR 15mm
DECORATIVE PROFILE 15mm
DEKORATIV PROFIL 15mm



Portail Battant et Coulissant
Swinging and Sliding Gates / Doppeltor und Schiebetor

DIMENSIONS
Dimensions / Maße
Largeur / Width / Breite (Minimum 2500mm / Maximum 4000mm)
Hauteur / Height / Höhe (Minimum 1000mm / Maximum 2200mm)

Portillon
Pedestrian Gate / Einzeltor

Largeur / Width / Breite (Minimum 800mm / Maximum 1500mm)
Hauteur / Height / Höhe (Minimum 1000mm / Maximum 2200mm)



CARACTÉRISTIQUES
Features / Eigenschaften



LAME RENFORCÉE POUR MOTORISATION
REINFORCED TRAVERSE FOR MOTORIZATION
VERSTÄRKTE PROFIL FÜR MOTOREINBAU



LAME 250mm
BLADE 250mm
LAMELLE 250mm



LAME ONDULÉE 100mm
CORRUGATED BLADE 100mm
GEWELLT LAMELLE 100mm



SANS TRAVERSE EN HAUT ET EN BAS
WITHOUT TOP AND BOTTOM CROSSBARS
OHNE QUERLATTE OBEN UND UNTEN

POSSIBILITÉS
Options / Optionen



SUR MESURE
BESPOKE
MAßANFERTIGUNG



Portail Battant / Swing Gate / Doppeltor
AT30

Portillon / Pedestrian Gate / Einzeltor
AT30

Portail Coulissant / Sliding Gate / Schiebetor
AT30

Clôture / Fence / Zaun
AG43

Tableau des Dimensions Possibles

Dimensions Chart / Maße Tabelle

Portail Battant et Coulissant & Portillon AT30
Pedestrian, Sliding and Swing Gates
Einzeltor, Doppeltor und Schiebetor

Hauteur / Height / Höhe
[1166 | 1366 | 1416 | 1616 | 1816 | 1866 | 2066]

Clôture AG43
Fence / Zaun

Largeur [Minimum 430mm / Maximum 2070mm]
Hauteur [714 | 814 | 914 | 1164 | 1364 | 1414
| 1564 | 1614 | 1814 | 1864]



DIMENSIONS
Dimensions / Maße

Portail Battant et Coulissant
Swinging and Sliding Gates / Doppeltor und Schiebetor
Largeur / Width / Breite (Minimum 2500mm / Maximum 4000mm)

Portillon
Pedestrian Gate / Einzeltor
Largeur / Width / Breite (Minimum 800mm / Maximum 1500mm)



AT31

AT32

AT33



CARACTÉRISTIQUES
Features / Eigenschaften



TUBE RENFORCÉE POUR MOTORISATION
REINFORCED PROFILE FOR MOTORIZATION
VERSTÄRKTES PROFIL FÜR MOTOREINBAU



LAME 250mm
BLADE 250mm
LAMELLE 250mm



TUBE 100mm et 250mm
TUBE 100mm and 250mm
ROHR 100mm und 250mm



SANS TRAVERSE EN HAUT ET EN BAS
WITHOUT TOP AND BOTTOM CROSSBARS
OHNE QUERLATTE OBEN UND UNTEN

POSSIBILITÉS
Options / Optionen



SUR MESURE
BESPOKE
MAßANFERTIGUNG

ACTUEL



Portail Battant / Swing Gate / Doppeltor
AT31

Portillon / Pedestrian Gate / Einzeltor
AT31

Portail Couissant / Sliding Gate / Schiebetor
AT31

Tableau des Dimensions Possibles

Dimensions Chart / Maße Tabelle

Portail Battant et Couissant & Portillon AT31

Hauteur [1076 | 1346 | 1616 | 1886]

Clôture AG44

Largeur [Minimum 430mm / Maximum 2070mm]

Hauteur [534 | 804 | 1074 | 1344 | 1614 | 1884]

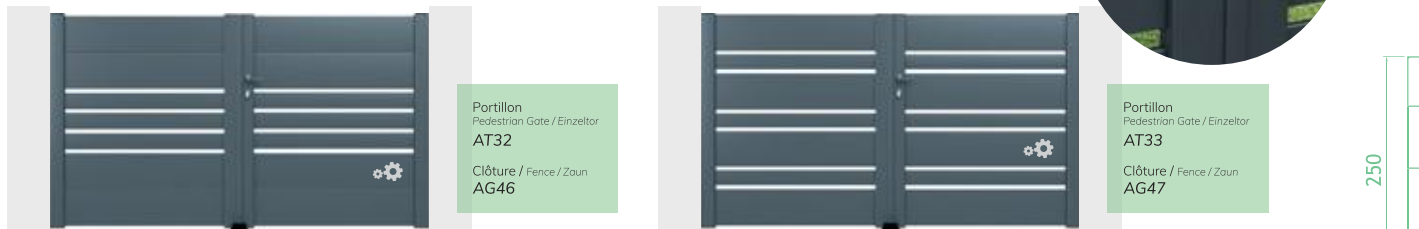

Portail Battant / Swing Gate / Doppeltor
AT32

Portillon
Pedestrian Gate / Einzeltor
AT32
Clôture / Fence / Zaun
AG46

Portail Battant / Swing Gate / Doppeltor
AT33

Portillon
Pedestrian Gate / Einzeltor
AT33
Clôture / Fence / Zaun
AG47

Tableau des Dimensions Possibles

Dimensions Chart / Maße Tabelle

Portail Battant et Couissant & Portillon AT32

Hauteur [1026 | 1146 | 1266 | 1396 | 1516 | 1646 | 1766 | 1896 | 2016]

Tableau des Dimensions Possibles

Dimensions Chart / Maße Tabelle

Portail Battant et Couissant & Portillon AT33

Hauteur [1046 | 1436 | 1826]

DIMENSIONS
Dimensions / Maße

Portail Battant et Couissant
Swinging and Sliding Gates / Doppeltor und Schiebetor

Largeur / Width / Breite (Minimum 2500mm / Maximum 4000mm)

Portillon
Pedestrian Gate / Einzeltor

Largeur / Width / Breite (Minimum 800mm / Maximum 1500mm)



CARACTÉRISTIQUES
Features / Eigenschaften



LAME RENFORCÉE POUR MOTORISATION
REINFORCED TRAVERSE FOR MOTORIZATION
VERSTÄRKTÉ PROFIL FÜR MOTOREINBAU



LAME 250mm
BLADE 250mm
LAMELLE 250mm



PROFIL DÉCOR 15mm
DECORATIVE PROFILE 15mm
DEKORATIV PROFIL 15mm



SANS TRAVERSE EN HAUT ET EN BAS
WITHOUT TOP AND BOTTOM CROSSBARS
OHNE QUERLATTE OBEN UND UNTEN

POSSIBILITÉS
Options / Optionen



SUR MESURE
BESPOKE
MAßANFERTIGUNG



Portail Battant / Swing Gate / Doppeltor
AT34

Portillon / Pedestrian Gate / Einzeltor
AT34

Portail Coulissant / Sliding Gate / Schiebetor
AT34

Clôture / Fence / Zaun
AG45



Tableau des Dimensions Possibles

Dimensions Chart / Maße Tabelle

Portail Battant et Coulissant & Portillon AT34

Hauteur [1061 | 1326 | 1591 | 1856]

Clôture AG45

Largeur [Minimum 430mm / Maximum 2070mm]

Hauteur [529 | 794 | 1059 | 1324 | 1589 | 1854]



Portail Battant / Swing Gate / Doppeltor
AT35

Portillon / Pedestrian Gate / Einzeltor
AT35

Portail Coulissant / Sliding Gate / Schiebetor
AT35

Clôture / Fence / Zaun
AG46



Tableau des Dimensions Possibles

Dimensions Chart / Maße Tabelle

Portail Battant et Coulissant & Portillon AT35

Hauteur [1016 | 1266 | 1516 | 1766 | 2016]

Clôture AG46

Largeur [Minimum 430mm / Maximum 2070mm]

Hauteur [514 | 764 | 1014 | 1264 | 1514 | 1764]

DIMENSIONS
Dimensions / Maße

Portail Battant et Coulissant
Swinging and Sliding Gates / Doppeltor und Schiebetor

Largeur / Width / Breite (Minimum 2500mm / Maximum 4000mm)

Portillon
Pedestrian Gate / Einzeltor

Largeur / Width / Breite (Minimum 800mm / Maximum 1500mm)







CARACTÉRISTIQUES
Features / Eigenschaften



LAME RENFORCÉE POUR MOTORISATION
REINFORCED TRAVERSE FOR MOTORIZATION
VERSTÄRKTE PROFIL FÜR MOTOREINBAU



TUBE PERSIENNÉE 160mm
LOUVERED TUBE 160mm
LAMELLEN MIT ROHR 160mm



SANS TRAVERSE EN HAUT ET EN BAS
WITHOUT TOP AND BOTTOM CROSSBARS
OHNE QUERLATTE OBEN UND UNTEN

POSSIBILITÉS
Options / Optionen



SUR MESURE
BESPOKE
MAßANFERTIGUNG



Portail Battant / Swing Gate / Doppeltor
AT36

Portillon / Pedestrian Gate / Einzeltor
AT36

Portail Coulissant / Sliding Gate / Schiebetor
AT36

Clôture / Fence / Zaun
AG52



Tableau des Dimensions Possibles
Dimensions Chart / Maße Tabelle

Portail Battant et Coulissant & Portillon AT36
Hauteur [1076 | 1226 | 1376 | 1526 | 1676 | 1826
| 1976]

Clôture AG52
Largeur [Minimum 430mm / Maximum 2070mm]
Hauteur [624 | 774 | 924 | 1074 | 1224 | 1374
| 1524 | 1674 | 1824]

DIMENSIONS
Dimensions / Maße

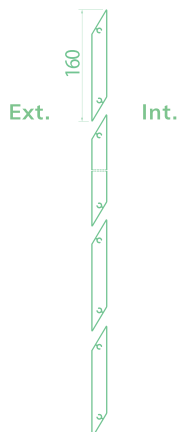
Portail Battant et Coulissant
Swinging and Sliding Gates / Doppeltor und Schiebetor
Largeur / Width / Breite (Minimum 2500mm / Maximum 4000mm)

Portillon
Pedestrian Gate / Einzeltor
Largeur / Width / Breite (Minimum 800mm / Maximum 1500mm)

A modern, dark grey aluminum gate with a decorative geometric cutout pattern. The gate is set against a light grey building with large windows. The foreground features a paved walkway and some greenery with white flowers.

**TÔLE
DÉCORATIVE**
DECORATED
ALUMINUM SHEET



CARACTÉRISTIQUES
Features / Eigenschaften



**TRAVERSE RENFORCÉE
POUR MOTORISATION**
REINFORCED TRAVERSE FOR MOTORIZATION
VERSTÄRKTE PROFIL FÜR MOTOREINBAU



LAME 200mm
BLADE 200mm
LAMELLE 200mm



TÔLE DÉCORATIVE
DECORATED ALUMINUM SHEET
DEKORATIV ALUMINIUMBLATT

POSSIBILITÉS
Options / Optionen



SUR MESURE
BESPOKE
MAßANFERTIGUNG



COULISSANT 2 VANTAUX
2 LEAVES SLIDING GATE
ZWEI FLÜGEL SCHIEBETOR

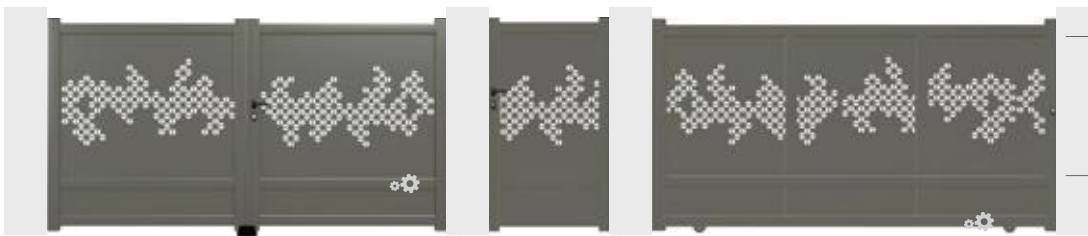

Portail Battant / Swing Gate / Doppeltor
AT37-L1

Portillon / Pedestrian Gate / Einzeltor
AT37-L1

Portail Coulissant / Sliding Gate / Schiebetor
AT37-L1

Tableau des Dimensions Possibles

Dimensions Chart / Maße Tabelle

Portail Battant et Coulissant & Portillon AT36

Hauteur [1500 | 1600 | 1700 | 1800 | 1900 | 2000 | 2100 | 2200]

Clôture AG23

Largeur [Minimum 430mm / Maximum 2070mm]
Hauteur [Minimum 500mm / Maximum 1000mm]

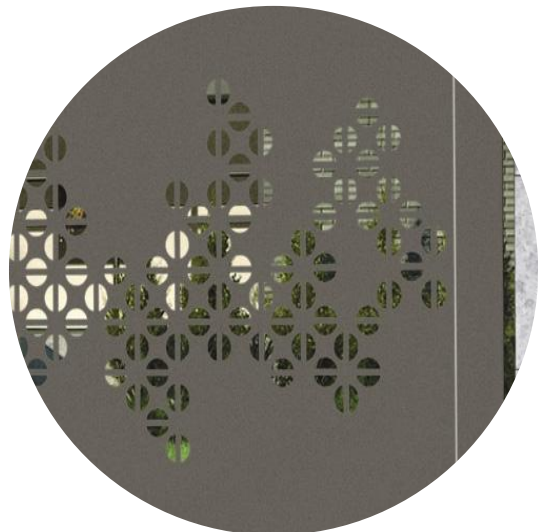

DIMENSIONS
Dimensions / Maße

Portail Battant et Coulissant
Swinging and Sliding Gates / Doppeltor und Schiebetor

Largeur / Width / Breite (Minimum 2500mm / Maximum 4000mm)

Portillon
Pedestrian Gate / Einzeltor

Largeur / Width / Breite (Minimum 800mm / Maximum 1500mm)

DÉCORS

DESIGNS

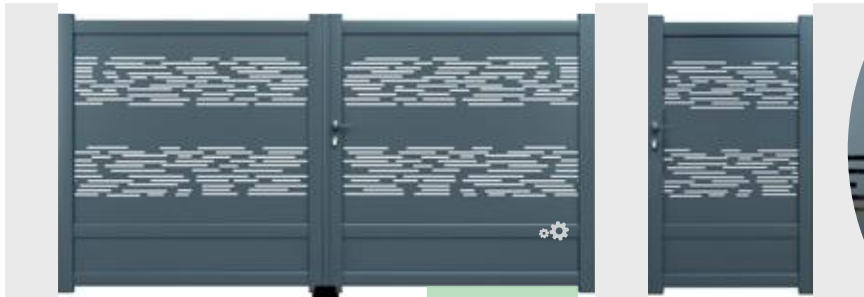

Portail Battant / Swing Gate / Doppeltor
AT37-L2

Portail Coulissant /
Sliding Gate / Schiebetor
AT37-L2

Portillon / Pedestrian Gate / Einzeltor
AT37-L2

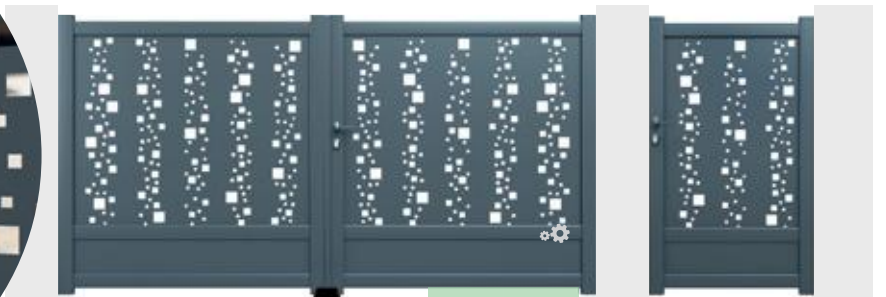

Portail Battant / Swing Gate / Doppeltor
AT37-L3

Portail Coulissant /
Sliding Gate / Schiebetor
AT37-L3

Portillon / Pedestrian Gate / Einzeltor
AT37-L3

Option

NUMÉRO D'ENTRÉE
Residence number / Wohnsitznummer
0123456789



Portail Battant / Swing Gate / Doppeltor
AT37-L4

Portail Coulissant /
Sliding Gate / Schiebetor
AT37-L4

Portillon / Pedestrian Gate / Einzeltor
AT37-L4



DIMENSIONS

Dimensions / Maße

Portail Battant et Coulissant
Swinging and Sliding Gates / Doppeltor und Schiebetor
Largeur / Width / Breite (Minimum 2500mm / Maximum 4000mm)

Portillon
Pedestrian Gate / Einzeltor
Largeur / Width / Breite (Minimum 800mm / Maximum 1500mm)

DÉCORS

DESIGNS



Portail Battant / Swing Gate / Doppeltor
AT37-L5

Portail Coulissant /
Sliding Gate / Schiebetor
AT37-L5

Portillon / Pedestrian Gate / Einzeltor
AT37-L5



Portail Battant / Swing Gate / Doppeltor
AT37-L6

Portail Coulissant /
Sliding Gate / Schiebetor
AT37-L6

Portillon / Pedestrian Gate / Einzeltor
AT37-L6



Portail Battant / Swing Gate / Doppeltor
AT37-L7

Portail Coulissant /
Sliding Gate / Schiebetor
AT37-L7

Portillon / Pedestrian Gate / Einzeltor
AT37-L7



DIMENSIONS

Dimensions / Maße

Portail Battant et Coulissant
Swinging and Sliding Gates / Doppeltor und Schiebetor
Largeur / Width / Breite (Minimum 2500mm / Maximum 4000mm)

Portillon
Pedestrian Gate / Einzeltor
Largeur / Width / Breite (Minimum 800mm / Maximum 1500mm)

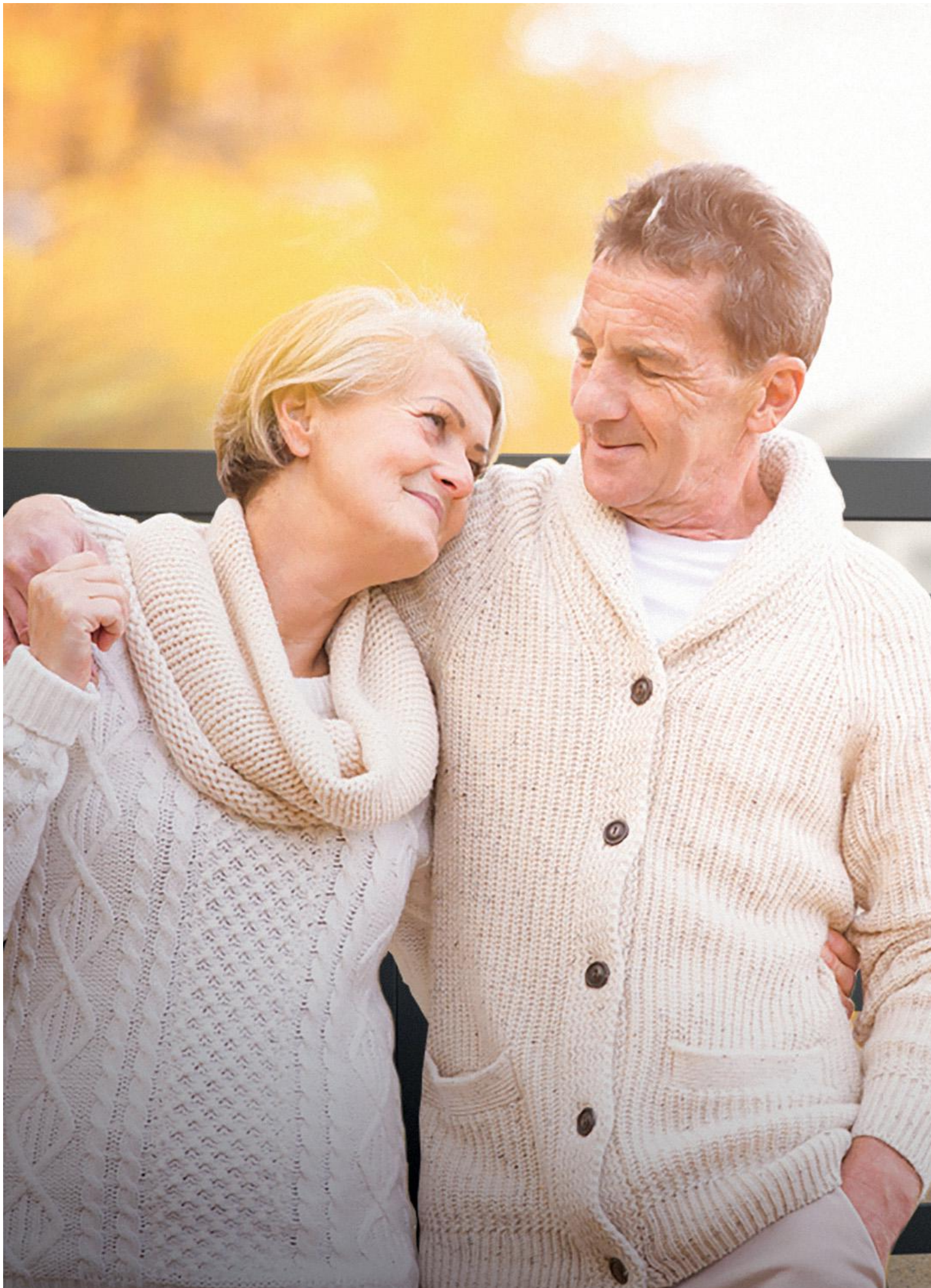



CLASSIC



DESCRIPTION

Avec des modèles qui combinent des éléments de design classique et moderne, la gamme Classic s'adapte à tous les styles architecturaux. Ces modèles sont composés de lames de 100mm et tubes de 70mm ou 100mm, permettant ainsi la possibilité de choisir entre modèles pleins, semi-ajourés ou ajourés, sélectionnant le degré d'intimité souhaité.

Composed by models that combine classic and modern design elements, the Classic range is suited to different architectural styles. Using 100mm blades, 70mm and 100mm tubes and choosing the type of infill: open work, semi-openwork or full fill; you can have the level of privacy you desire.

PLEIN FULL FILL / GEFÜLLT

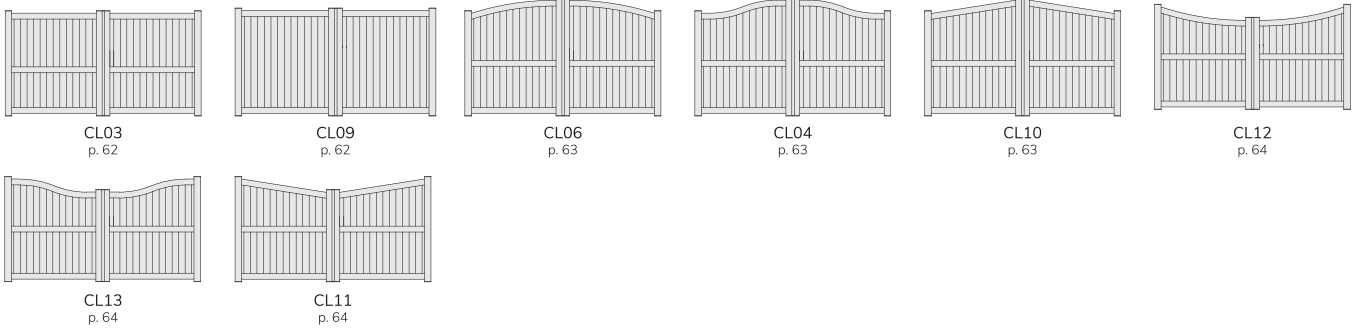

AJOURÉ OPENWORK / OFFEN

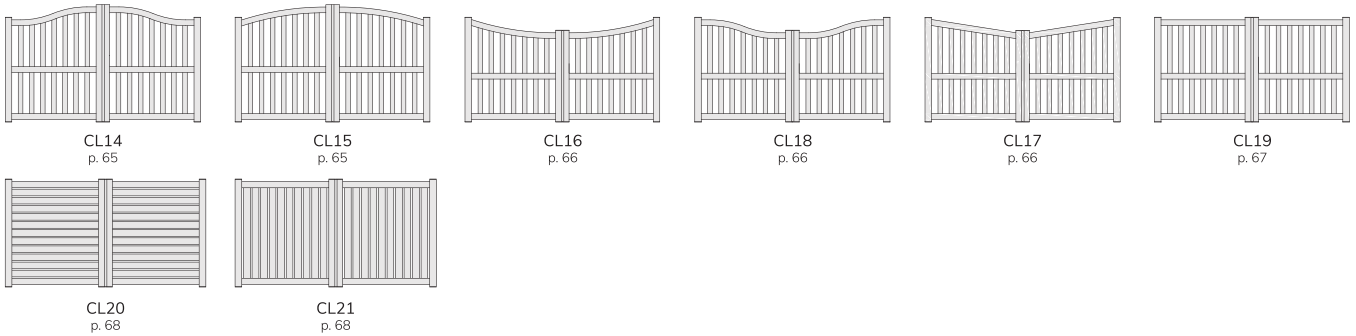

SEMI-AJOURÉ SEMI-OPENWORK / HALB OFFEN

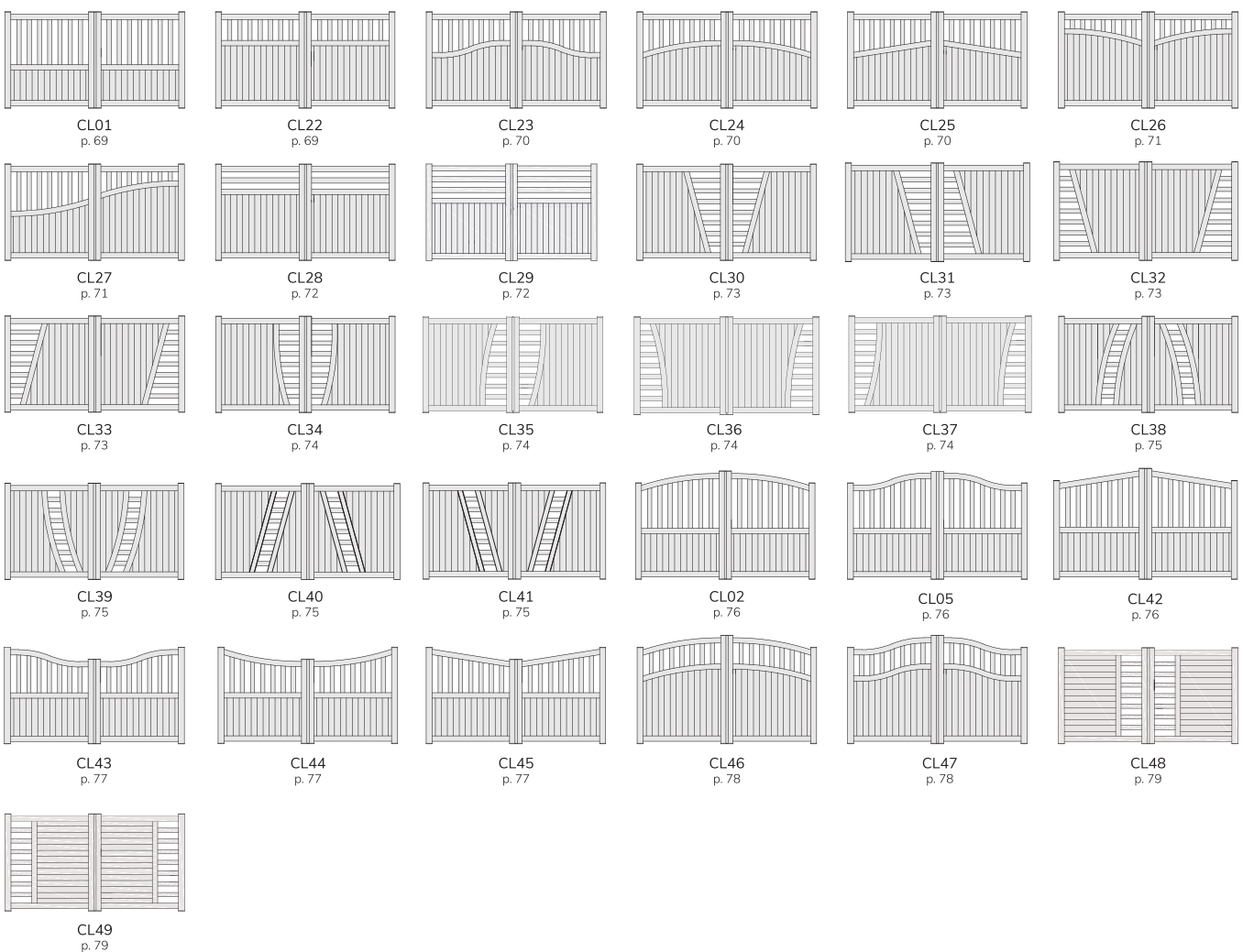

CL03

CL09

CLASSIC



CARACTÉRISTIQUES
Features / Eigenschaften



**TRAVERSE RENFORCÉE
POUR MOTORISATION**
REINFORCED TRAVERSE FOR MOTORIZATION
VERSTÄRKTES PROFIL FÜR MOTOREINBAU



LAME 100mm
BLADE 100mm
LAMELLE 100mm

POSSIBILITÉS
Options / Optionen



SUR MESURE
BESPOKE
MAßANFERTIGUNG



COULISSANT 2 VANTAUX
2 LEAVES SLIDING GATE
ZWEI FLÜGEL SCHIEBETOR



Portail Battant / Swing Gate / Doppeltor
CL03

Portillon / Pedestrian Gate / Einzeltor
CL03

Portail Coulissant / Sliding Gate / Schiebetor
CL03

Clôture / Fence / Zaun
AG15

Portail Battant et Coulissant
Swinging and Sliding Gates / Doppeltor und Schiebetor

DIMENSIONS
Dimensions / Maße

Largeur / Width / Breite (Minimum 2500mm / Maximum 5000mm)
Hauteur / Height / Höhe (Minimum 1000mm / Maximum 2200mm)

Portillon
Pedestrian Gate / Einzeltor

Largeur / Width / Breite (Minimum 800mm / Maximum 1500mm)
Hauteur / Height / Höhe (Minimum 1000mm / Maximum 2200mm)



Portail Battant / Swing Gate / Doppeltor
CL09

Portillon / Pedestrian Gate / Einzeltor
CL09

Portail Coulissant / Sliding Gate / Schiebetor
CL09

Portail Battant et Coulissant
Swinging and Sliding Gates / Doppeltor und Schiebetor

DIMENSIONS
Dimensions / Maße

Largeur / Width / Breite (Minimum 2500mm / Maximum 5000mm)
Hauteur / Height / Höhe (Minimum 1000mm / Maximum 2000mm)



CL03 / CL09:
OPTIONS REMPLISSAGE
Infill Options / Fülloptionen



CL06

CL04

CL10



CARACTÉRISTIQUES
Features / Eigenschaften



TRAVERSE RENFORCÉE POUR MOTORISATION
REINFORCED TRAVERSE FOR MOTORIZATION
VERSTÄRKTES PROFIL FÜR MOTOREINBAU



LAME 100mm
BLADE 100mm
LAMELLE 100mm

POSSIBILITÉS
Options / Optionen



SUR MESURE
BESPOKE
MAßANFERTIGUNG



COULISSANT 2 VANTAUX
2 LEAVES SLIDING GATE
ZWEI FLÜGEL SCHIEBETOR



Clôture / Fence / Zaun
AG15

Portail Battant / Swing Gate / Doppeltor
CL06

Portillon / Pedestrian Gate / Einzeltor
CL04

Portail Coulissant / Sliding Gate / Schiebetor
CL06



Portail Battant / Swing Gate / Doppeltor
CL04

Portail Coulissant / Sliding Gate / Schiebetor
CL04

CL06 / CL04:
OPTIONS REEMPLISSAGE
Infill Options / Fülloptionen



Portail Battant et Coulissant
Swinging and Sliding Gates / Doppeltor und Schiebetor

DIMENSIONS
Dimensions / Maße

Largeur / Width / Breite (Minimum 3000mm / Maximum 5000mm)
Hauteur / Height / Höhe (Minimum 1000mm / Maximum 2000mm)

Portillon
Pedestrian Gate / Einzeltor

Largeur / Width / Breite (Minimum 800mm / Maximum 1500mm)
Hauteur / Height / Höhe (Minimum 1000mm / Maximum 2000mm)



Portail Battant / Swing Gate / Doppeltor
CL10

Portail Coulissant / Sliding Gate / Schiebetor
CL10

DIMENSIONS
Dimensions / Maße

Portail Battant et Coulissant
Swinging and Sliding Gates / Doppeltor und Schiebetor
Largeur / Width / Breite (Minimum 2500mm / Maximum 5000mm)
Hauteur / Height / Höhe (Minimum 1000mm / Maximum 2000mm)

CL12

CL13

CL11

CLASSIC

CARACTÉRISTIQUES
Features / Eigenschaften



**TRAVERSE RENFORCÉE
POUR MOTORISATION**
REINFORCED PROFILE FOR MOTORIZATION
VERSTÄRKTES PROFIL FÜR MOTOREINBAU



LAME 100mm
BLADE 100mm
LAMELLE 100mm

POSSIBILITÉS
Options / Optionen



SUR MESURE
BESPOKE
MAßANFERTIGUNG



COULISSANT 2 VANTAUX
2 LEAVES SLIDING GATE
ZWEI FLÜGEL SCHIEBETOR



Portail Battant / Swing Gate / Doppeltor
CL12

Portillon / Pedestrian Gate / Einzeltor
CL12

Portail Coulissant / Sliding Gate / Schiebetor
CL12

Clôture / Fence / Zaun
AG15



Portail Battant / Swing Gate / Doppeltor
CL13

Portail Coulissant / Sliding Gate / Schiebetor
CL13

CL12 / CL13:
OPTIONS REEMPLISSAGE
Infill Options / Fülloptionen



Portail Battant et Coulissant
Swinging and Sliding Gates / Doppeltor und Schiebetor

DIMENSIONS
Dimensions / Maße
Largeur / Width / Breite (Minimum 3000mm / Maximum 5000mm)
Hauteur / Height / Höhe (Minimum 1000mm / Maximum 2200mm)

Portillon
Pedestrian Gate / Einzeltor

Largeur / Width / Breite (Minimum 800mm / Maximum 1500mm)
Hauteur / Height / Höhe (Minimum 1000mm / Maximum 2200mm)



Portail Battant / Swing Gate / Doppeltor
CL11

Portail Coulissant / Sliding Gate / Schiebetor
CL11

DIMENSIONS
Dimensions / Maße

Portail Battant et Coulissant
Swinging and Sliding Gates / Doppeltor und Schiebetor
Largeur / Width / Breite (Minimum 2500mm / Maximum 5000mm)
Hauteur / Height / Höhe (Minimum 1000mm / Maximum 2200mm)

CL14

CL15



CARACTÉRISTIQUES
Features / Eigenschaften



**TRAVERSE RENFORCÉE
POUR MOTORISATION**
REINFORCED PROFILE FOR MOTORIZATION
VERSTÄRKTE PROFIL FÜR MOTOREINBAU



TUBE 70mm
TUBE 70mm
R0+R1 70mm

POSSIBILITÉS
Options / Optionen



SUR MESURE
BESPOKE
MAßANFERTIGUNG



COULISSANT 2 VANTAUX
2 LEAVES SLIDING GATE
ZWEI FLÜGEL SCHIEBETOR



Clôture / Fence / Zaun
AG12

Portail Battant / Swing Gate / Doppeltor
CL14

Portillon / Pedestrian Gate / Einzeltor
CL14

Portail Couissant / Sliding Gate / Schiebetor
CL14



Portail Battant / Swing Gate / Doppeltor
CL15

Portail Couissant / Sliding Gate / Schiebetor
CL15



Portail Battant et Couissant
Swinging and Sliding Gates / Doppeltor und Schiebetor

DIMENSIONS
Dimensions / Maße

Largeur / Width / Breite (Minimum 3000mm / Maximum 5000mm)
Hauteur / Height / Höhe (Minimum 1000mm / Maximum 2000mm)

Portillon
Pedestrian Gate / Einzeltor

Largeur / Width / Breite (Minimum 800mm / Maximum 1500mm)
Hauteur / Height / Höhe (Minimum 1000mm / Maximum 2000mm)

CL16

CL18

CL17

CLASSIC

CARACTÉRISTIQUES
Features / Eigenschaften



**TRAVERSE RENFORCÉE
POUR MOTORISATION**
REINFORCED PROFILE FOR MOTORIZATION
VERSTÄRKTE PROFIL FÜR MOTOREINBAU



TUBE 70mm
TUBE 70mm
ROHR 70mm

POSSIBILITÉS
Options / Optionen



SUR MESURE
BESPOKE
MAßANFERTIGUNG



COULISSANT 2 VANTAUX
2 LEAVES SLIDING GATE
ZWEI FLÜGEL SCHIEBETOR

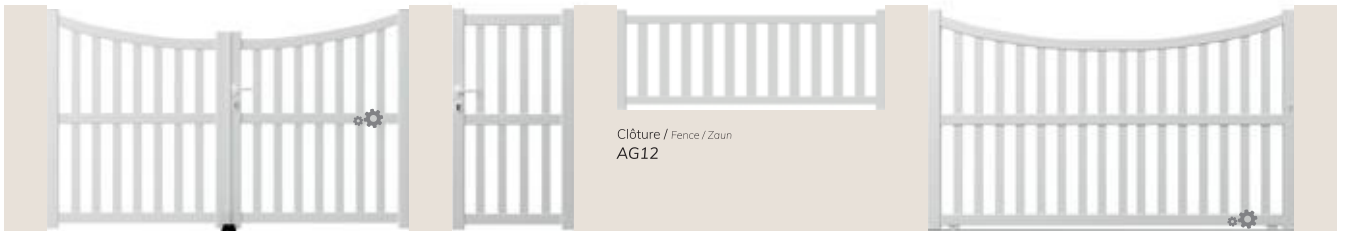

Portail Battant / Swing Gate / Doppeltor
CL16

Portillon / Pedestrian Gate / Einzeltor
CL16

Portail Coulissant / Sliding Gate / Schiebetor
CL16



Portail Battant / Swing Gate / Doppeltor
CL18

Portail Coulissant / Sliding Gate / Schiebetor
CL18

Portail Battant et Coulissant
Swinging and Sliding Gates / Doppeltor und Schiebetor

DIMENSIONS Largeur / Width / Breite (Minimum 3000mm / Maximum 5000mm)
Dimensions / Maße Hauteur / Height / Höhe (Minimum 1000mm / Maximum 2200mm)

Portillon
Pedestrian Gate / Einzeltor

Largeur / Width / Breite (Minimum 800mm / Maximum 1500mm)
Hauteur / Height / Höhe (Minimum 1000mm / Maximum 2200mm)



Portail Battant / Swing Gate / Doppeltor
CL17

Portail Coulissant / Sliding Gate / Schiebetor
CL17

DIMENSIONS
Dimensions / Maße

Portail Battant et Coulissant
Swinging and Sliding Gates / Doppeltor und Schiebetor
Largeur / Width / Breite (Minimum 2500mm / Maximum 5000mm)
Hauteur / Height / Höhe (Minimum 1000mm / Maximum 2200mm)



CARACTÉRISTIQUES
Features / Eigenschaften



**TRAVERSE RENFORCÉE
POUR MOTORISATION**
REINFORCED PROFIL FOR MOTORIZATION
VERSTÄRKTE PROFIL FÜR MOTOREINBAU



TUBE 70mm
TUBE 70mm
ROHR 70mm

POSSIBILITÉS
Options / Optionen



SUR MESURE
BESPOKE
MAßANFERTIGUNG



COULISSANT 2 VANTAUX
2 LEAVES SLIDING GATE
ZWEI FLÜGEL SCHIEBETOR



Clôture / Fence / Zaun
AG12

Portail Battant / Swing Gate / Doppeltor
CL19

Portillon / Pedestrian Gate / Einzeltor
CL19

Portail Coulissant / Sliding Gate / Schiebetor
CL19

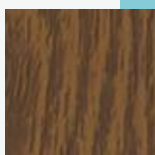

**OPTION
TON BOIS**
OPTION WOOD FINISHING
OPTION HOLZDEKOR



Portail Battant / Swing Gate / Doppeltor
CL19

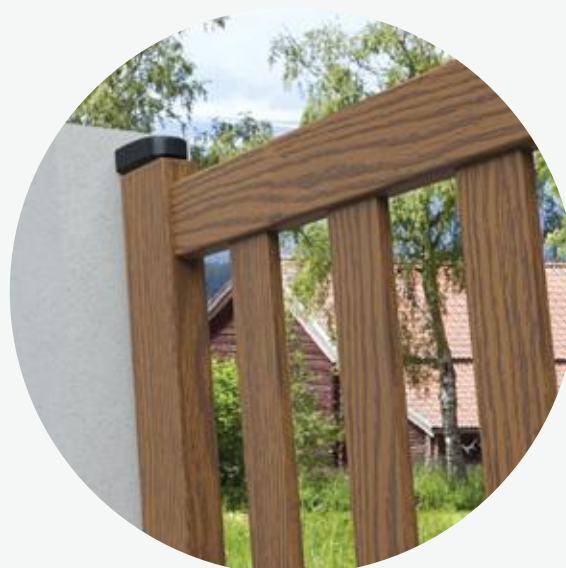

Portail Battant et Coulissant
Swinging and Sliding Gates / Doppeltor und Schiebetor

DIMENSIONS
Dimensions / Maße

Largeur / Width / Breite (Minimum 2500mm / Maximum 5000mm)
Hauteur / Height / Höhe (Minimum 1000mm / Maximum 2200mm)

Portillon
Pedestrian Gate / Einzeltor

Largeur / Width / Breite (Minimum 800mm / Maximum 1500mm)
Hauteur / Height / Höhe (Minimum 1000mm / Maximum 2200mm)

CL20

CL21



CARACTÉRISTIQUES
Features / Eigenschaften



TRaverse RENFORCÉE POUR MOTORISATION
REINFORCED TRAVERSE FOR MOTORIZATION
VERSTÄRKTES PROFIL FÜR MOTOREINBAU



TUBE 100mm
TUBE 100mm
ROHR 100mm

POSSIBILITÉS
Options / Optionen



SUR MESURE
BESPOKE
MAßANFERTIGUNG



COULISSANT 2 VANTAUX
2 LEAVES SLIDING GATE
ZWEI FLÜGEL SCHIEBETOR

CLASSIC

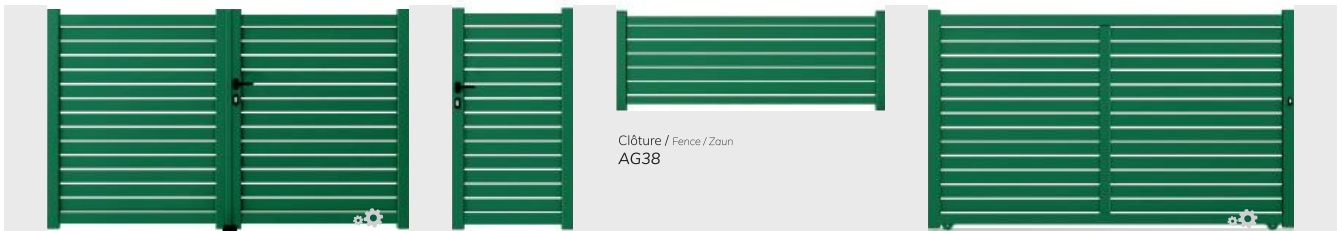

Portail Battant / Swing Gate / Doppeltor
CL20

Portillon / Pedestrian Gate / Einzeltor
CL20

Portail Coulissant / Sliding Gate / Schiebetor
CL20

Clôture / Fence / Zaun
AG38



Portail Battant / Swing Gate / Doppeltor
CL21

Portillon / Pedestrian Gate / Einzeltor
CL21

Portail Coulissant / Sliding Gate / Schiebetor
CL21

Clôture / Fence / Zaun
AG39

Portail Battant et Coulissant
Swinging and Sliding Gates / Doppeltor und Schiebetor

DIMENSIONS
Dimensions / Maße
Largeur / Width / Breite (Minimum 2500mm / Maximum 4000mm)
Hauteur / Height / Höhe (Minimum 1000mm / Maximum 2000mm)

Portillon
Pedestrian Gate / Einzeltor

Largeur / Width / Breite (Minimum 800mm / Maximum 1500mm)
Hauteur / Height / Höhe (Minimum 1000mm / Maximum 2000mm)

CL01

CL22



CARACTÉRISTIQUES
Features / Eigenschaften



**TRAVERSE RENFORCÉE
POUR MOTORISATION**
REINFORCED PROFIL FOR MOTORIZATION
VERSTÄRKTES PROFIL FÜR MOTOREINBAU



TUBE 70mm
TUBE 70mm
ROHR 70mm



LAME 100mm
BLADE 100mm
LAMELLE 100mm

POSSIBILITÉS
Options / Optionen



SUR MESURE
BESPOKE
MAßANFERTIGUNG



COULISSANT 2 VANTAUX
2 LEAVES SLIDING GATE
ZWEI FLÜGEL SCHIEBETOR

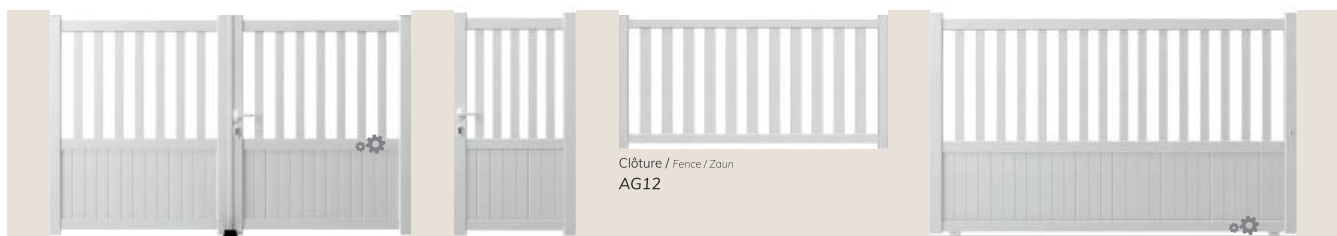

Portail Battant / Swing Gate / Doppeltor
CL01

Portillon / Pedestrian Gate / Einzeltor
CL01

Portail Couissant / Sliding Gate / Schiebetor
CL01

Clôture / Fence / Zaun
AG12

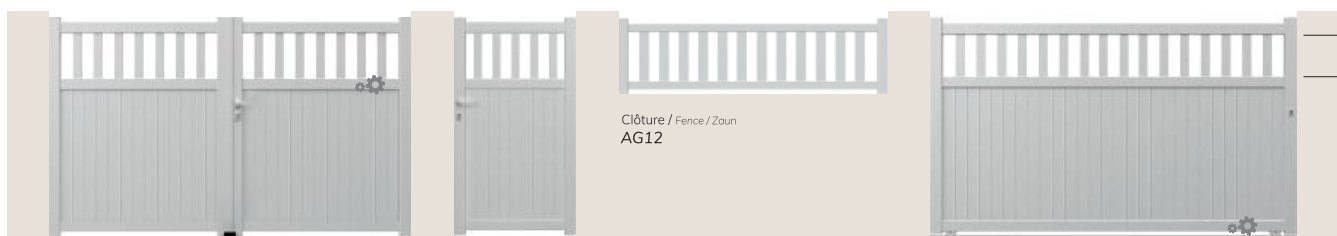

Portail Battant / Swing Gate / Doppeltor
CL22

Portillon / Pedestrian Gate / Einzeltor
CL22

Portail Couissant / Sliding Gate / Schiebetor
CL22

Hauteur Fixe /
Fixed Height / Feste Höhe

Clôture / Fence / Zaun
AG12

OPTIONS REMPLISSAGE
Infill Options / Fülloptionen



Portail Battant et Couissant
Swinging and Sliding Gates / Doppeltor und Schiebetor

DIMENSIONS
Dimensions / Maße
Largeur / Width / Breite (Minimum 2500mm / Maximum 5000mm)
Hauteur / Height / Höhe (Minimum 1000mm / Maximum 2200mm)

Portillon
Pedestrian Gate / Einzeltor

Largeur / Width / Breite (Minimum 800mm / Maximum 1500mm)
Hauteur / Height / Höhe (Minimum 1000mm / Maximum 2200mm)

CL23

CL24

CL25



CLASSIC

CARACTÉRISTIQUES
Features / Eigenschaften



**TRAVERSE RENFORCÉE
POUR MOTORISATION**
REINFORCED PROFILE FOR MOTORIZATION
VERSTÄRKTES PROFIL FÜR MOTOREINBAU



TUBE 70mm
TUBE 70mm
ROHR 70mm



LAME 100mm
BLADE 100mm
LAMELLE 100mm

POSSIBILITÉS
Options / Optionen



SUR MESURE
BESPOKE
MAßANFERTIGUNG



COULISSANT 2 VANTAUX
2 LEAVES SLIDING GATE
ZWEI FLÜGEL SCHIEBETOR



Portail Battant / Swing Gate / Doppeltor
CL23

Portillon / Pedestrian Gate / Einzeltor
CL23

Portail Coulissant / Sliding Gate / Schiebetor
CL23



Portail Battant / Swing Gate / Doppeltor
CL24

Portail Coulissant / Sliding Gate / Schiebetor
CL24

Portail Battant et Coulissant
Swinging and Sliding Gates / Doppeltor und Schiebetor

DIMENSIONS
Dimensions / Maße

Largeur / Width / Breite (Minimum 3000mm / Maximum 5000mm)
Hauteur / Height / Höhe (Minimum 1000mm / Maximum 2200mm)

Portillon
Pedestrian Gate / Einzeltor

Largeur / Width / Breite (Minimum 800mm / Maximum 1500mm)
Hauteur / Height / Höhe (Minimum 1000mm / Maximum 2200mm)



Portail Battant / Swing Gate / Doppeltor
CL25

Portail Coulissant / Sliding Gate / Schiebetor
CL25

DIMENSIONS
Dimensions / Maße

Portail Battant et Coulissant
Swinging and Sliding Gates / Doppeltor und Schiebetor

Largeur / Width / Breite (Minimum 2500mm / Maximum 5000mm)
Hauteur / Height / Höhe (Minimum 1000mm / Maximum 2200mm)

CL26

CL27



CARACTÉRISTIQUES
Features / Eigenschaften



**TRAVERSE RENFORCÉE
POUR MOTORISATION**
REINFORCED PROFILE FOR MOTORIZATION
VERSTÄRKTE PROFIL FÜR MOTOREINBAU



TUBE 70mm
TUBE 70mm
ROHR 70mm



LAME 100mm
BLADE 100mm
LAMELLE 100mm

POSSIBILITÉS
Options / Optionen



SUR MESURE
BESPOKE
MAßANFERTIGUNG



COULISSANT 2 VANTAUX
2 LEAVES SLIDING GATE
ZWEI FLÜGEL SCHIEBETOR

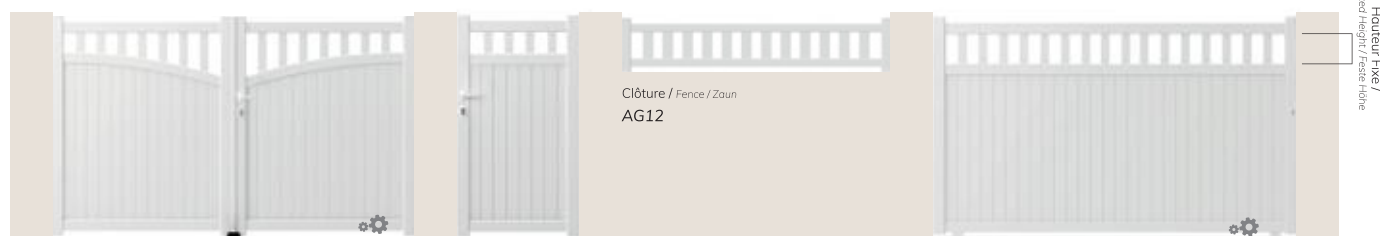

Portail Battant / Swing Gate / Doppeltor
CL26

Portillon / Pedestrian Gate / Einzeltor
CL26

Portail Couissant / Sliding Gate / Schiebetor
CL26

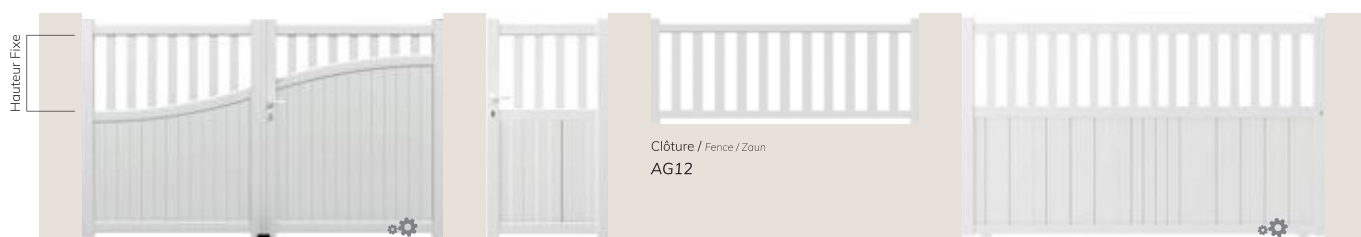

Portail Battant / Swing Gate / Doppeltor
CL27

Portillon / Pedestrian Gate / Einzeltor
CL27

Portail Couissant / Sliding Gate / Schiebetor
CL27

DIMENSIONS
Dimensions / Maße

Portail Battant et Couissant
Swinging and Sliding Gates / Doppeltor und Schiebetor

Largeur / Width / Breite (Minimum 3000mm / Maximum 5000mm)
Hauteur / Height / Höhe (Minimum 1000mm / Maximum 2200mm)

Portillon
Pedestrian Gate / Einzeltor

Largeur / Width / Breite (Minimum 800mm / Maximum 1500mm)
Hauteur / Height / Höhe (Minimum 1000mm / Maximum 2200mm)



CLASSIC



CL28

CL29



CLASSIC

CARACTÉRISTIQUES
Features / Eigenschaften



TRAVERSE RENFORCÉE POUR MOTORISATION
REINFORCED PROFILE FOR MOTORIZATION
VERSTÄRKTES PROFIL FÜR MOTOREINBAU



TRAVERSE 90mm
CROSS BEAM 90mm
DER SCHWEBEBALKEN 90mm



LAME 100mm
BLADE 100mm
LAMELLE 100mm

POSSIBILITÉS
Options / Optionen



SUR MESURE
BESPOKE
MAßANFERTIGUNG



COULISSANT 2 VANTAUX
2 LEAVES SLIDING GATE
ZWEI FLÜGEL SCHIEBETOR

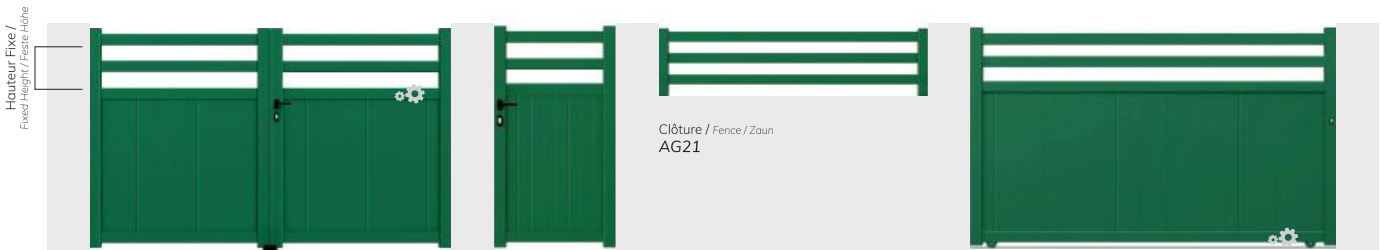

Portail Battant / Swing Gate / Doppeltor
CL28

Portillon / Pedestrian Gate / Einzeltor
CL28

Portail Coulissant / Sliding Gate / Schiebetor
CL28

Portail Battant et Coulissant
Swinging and Sliding Gates / Doppeltor und Schiebetor

DIMENSIONS
Dimensions / Maße

Largeur / Width / Breite (Minimum 2500mm / Maximum 5000mm)
Hauteur / Height / Höhe (Minimum 1000mm / Maximum 2200mm)

Portillon
Pedestrian Gate / Einzeltor

Largeur / Width / Breite (Minimum 800mm / Maximum 1500mm)
Hauteur / Height / Höhe (Minimum 1000mm / Maximum 2200mm)



Portail Battant / Swing Gate / Doppeltor
CL29

Portillon / Pedestrian Gate / Einzeltor
CL29

Portail Coulissant / Sliding Gate / Schiebetor
CL29

Portail Battant et Coulissant
Swinging and Sliding Gates / Doppeltor und Schiebetor

DIMENSIONS
Dimensions / Maße

Largeur / Width / Breite (Minimum 2500mm / Maximum 5000mm)
Hauteur / Height / Höhe (Minimum 1400mm / Maximum 2200mm)

Portillon
Pedestrian Gate / Einzeltor

Largeur / Width / Breite (Minimum 800mm / Maximum 1500mm)
Hauteur / Height / Höhe (Minimum 1400mm / Maximum 2200mm)

CL28 / CL29:
OPTIONS REMPLISSAGE
Infill Options / Fülloptionen



CL30

CL31

CL32

CL33

20

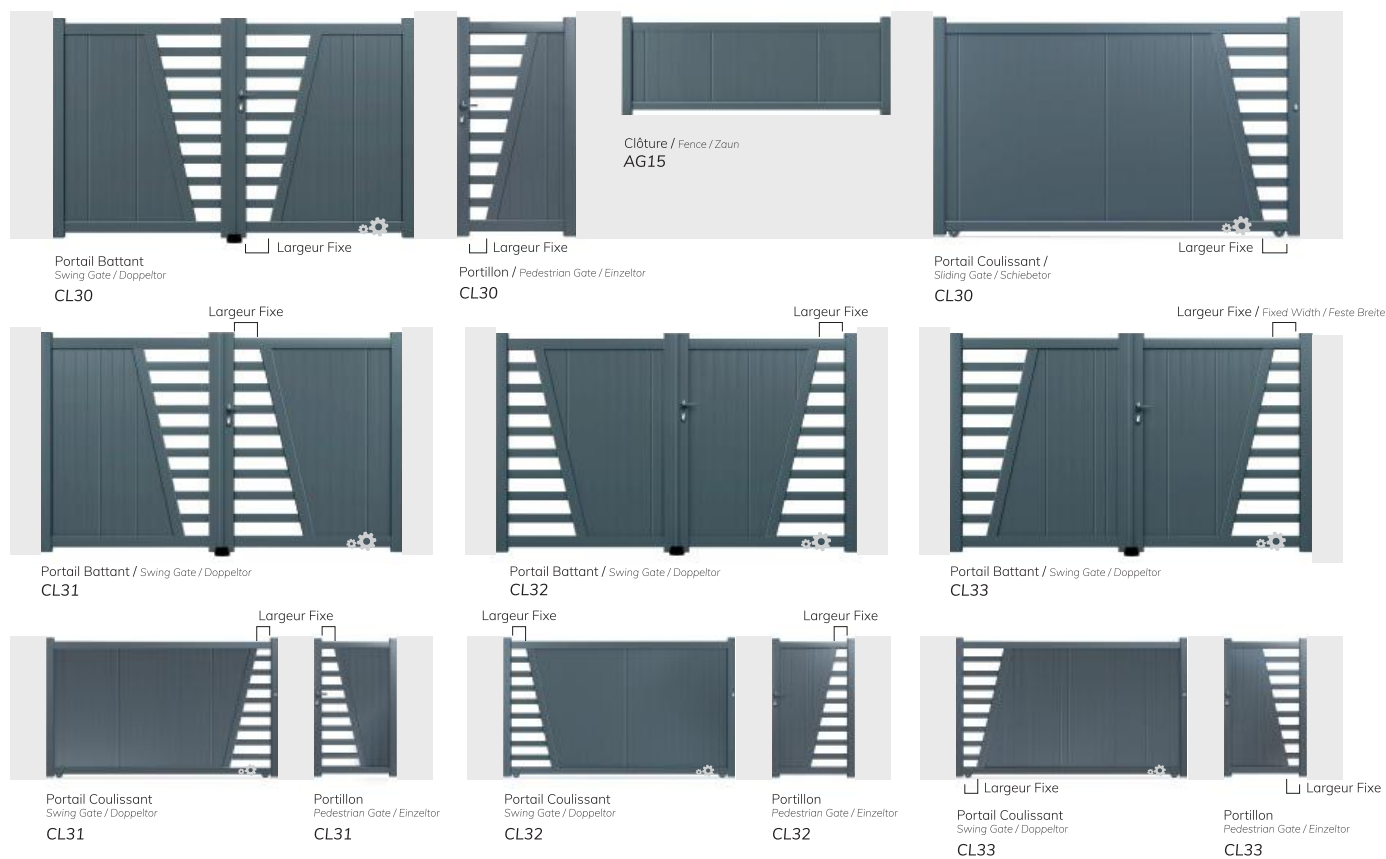
CARACTÉRISTIQUES
Features / Eigenschaften**TRAVERSE RENFORCÉE
POUR MOTORISATION**
REINFORCED PROFIL FOR MOTORIZATION
VERSTÄRKTE PROFIL FÜR MOTOREINBAU**TUBE 70mm**
TUBE 70mm
ROHR 70mm**LAME 100mm**
BLADE 100mm
LAMELLE 100mmPOSSIBILITÉS
Options / Optionen**SUR MESURE**
BESPOKE
MAßANFERTIGUNG**COULISSANT 2 VANTAUX**
2 LEAVES SLIDING GATE
ZWEI FLÜGEL SCHIEBETOROPTIONS REMPLISSAGE
Infill Options / Fülloptionen**Portail Battant et Couissant**
Swinging and Sliding Gates / Doppeltor und SchiebetorLargeur / Width / Breite (Minimum 2500mm / Maximum 5000mm)
Hauteur / Height / Höhe (Minimum 1000mm / Maximum 2000mm)**Portillon**
Pedestrian Gate / EinzeltorLargeur / Width / Breite (Minimum 1000mm / Maximum 1500mm)
Hauteur / Height / Höhe (Minimum 1000mm / Maximum 2000mm)**DIMENSIONS**
Dimensions / Maße

CL34

CL35

CL36

CL37

CLASSIC

CARACTÉRISTIQUES
Features / Eigenschaften



**TRAVERSE RENFORCÉE
POUR MOTORISATION**
REINFORCED TRAVERSE FOR MOTORIZATION
VERSTÄRKTE PROFIL FÜR MOTOREINBAU



TUBE 70mm
TUBE 70mm
ROHR 70mm



LAME 100mm
BLADE 100mm
LAMELLE 100mm



SUR MESURE
BESPOKE
MAßANFERTIGUNG



COULISSANT 2 VANTAUX
2 LEAVES SLIDING GATE
ZWEI FLÜGEL SCHIEBETOR

POSSIBILITÉS
Options / Optionen

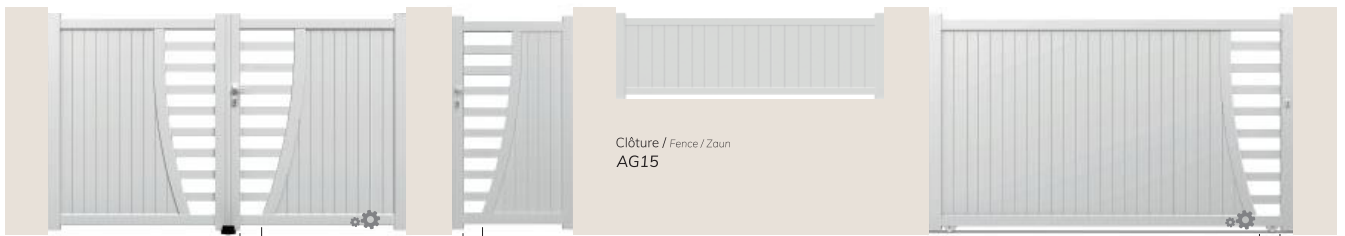

Portail Battant
Swing Gate / Doppeltor
CL34

Largeur Fixe

Largeur Fixe

Portillon / Pedestrian Gate / Einzeltor
CL34

Portail Coulissant / Sliding Gate / Schiebetor
CL34

Largeur Fixe



Largeur Fixe / Fixed Width / Feste Breite

Portail Battant / Swing Gate / Doppeltor
CL35



Largeur Fixe

Portail Battant / Swing Gate / Doppeltor
CL36



Largeur Fixe

Portail Battant / Swing Gate / Doppeltor
CL37

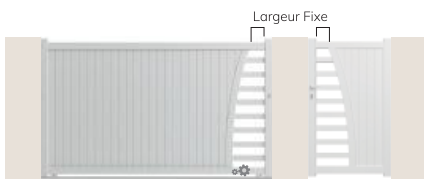

Largeur Fixe

Portail Coulissant
Swing Gate / Doppeltor
CL35



Largeur Fixe

Portail Coulissant
Swing Gate / Doppeltor
CL36



Largeur Fixe

Portail Coulissant
Swing Gate / Doppeltor
CL37

Portillon
Pedestrian Gate / Einzeltor
CL37



OPTIONS REPLEISSAGE
Infill Options / Fülloptionen

Portail Battant et Coulissant
Swinging and Sliding Gates / Doppeltor und Schiebetor

Largeur / Width / Breite (Minimum 2500mm / Maximum 5000mm)
Hauteur / Height / Höhe (Minimum 1000mm / Maximum 2000mm)

Portillon
Pedestrian Gate / Einzeltor

Largeur / Width / Breite (Minimum 800mm / Maximum 1500mm)
Hauteur / Height / Höhe (Minimum 1000mm / Maximum 2000mm)

CL38

CL39

CL40

CL41

CARACTÉRISTIQUES
Features / Eigenschaften



**TRAVERSE RENFORCÉE
POUR MOTORISATION**
REINFORCED TRAVERSE FOR MOTORIZATION
VERSTÄRKTE PROFIL FÜR MOTOREINBAU



TUBE 70mm
TUBE 70mm
ROHR 70mm



LAME 100mm
BLADE 100mm
LAMELLE 100mm

POSSIBILITÉS
Options / Optionen



SUR MESURE
BESPOKE
MAßANFERTIGUNG



COULISSANT 2 VANTAUX
2 LEAVES SLIDING GATE
ZWEI FLÜGEL SCHIEBETOR



Portail Battant et Coulissant
Swinging and Sliding Gates / Doppeltor und Schiebetor

DIMENSIONS
Dimensions / Maße

Largeur / Width / Breite (Minimum 2500mm / Maximum 5000mm)
Hauteur / Height / Höhe (Minimum 1000mm / Maximum 2000mm)

Portillon
Pedestrian Gate / Einzeltor

Largeur / Width / Breite (Minimum 800mm / Maximum 1500mm)
Hauteur / Height / Höhe (Minimum 1000mm / Maximum 2000mm)

CL02

CL05

CL42

CLASSIC

CARACTÉRISTIQUES
Features / Eigenschaften



**TRAVERSE RENFORCÉE
POUR MOTORISATION**
REINFORCED TRAVERSE FOR MOTORIZATION
VERSTÄRKTE PROFIL FÜR MOTOREINBAU



TUBE 70mm
TUBE 70mm
ROHR 70mm



LAME 100mm
BLADE 100mm
LAMELLE 100mm

POSSIBILITÉS
Options / Optionen



SUR MESURE
BESPOKE
MAßANFERTIGUNG



COULISSANT 2 VANTAUX
2 LEAVES SLIDING GATE
ZWEI FLÜGEL SCHIEBETOR

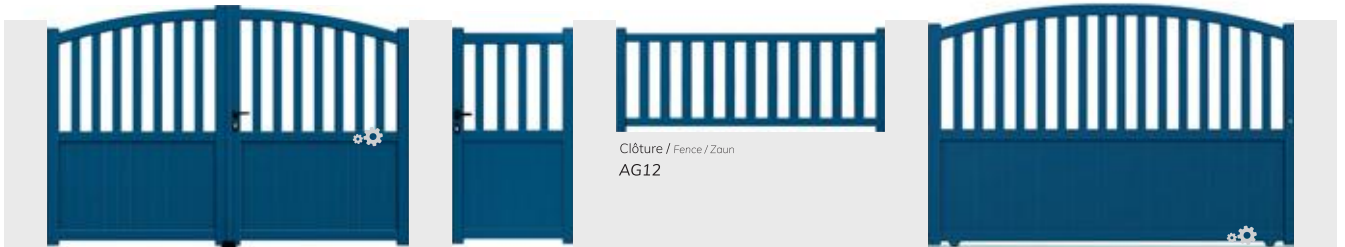

Portail Battant / Swing Gate / Doppeltor
CL02

Portillon / Pedestrian Gate / Einzeltor
CL02

Portail Coulissant / Sliding Gate / Schiebetor
CL02



Portail Battant / Swing Gate / Doppeltor
CL05

Portail Coulissant / Sliding Gate / Schiebetor
CL05

CL02 / CL05 / CL42:
OPTIONS REMPLISSAGE
Infill Options / Fülloptionen



Portail Battant et Coulissant
Swinging and Sliding Gates / Doppeltor und Schiebetor

DIMENSIONS
Dimensions / Maße

Largeur / Width / Breite (Minimum 3000mm / Maximum 5000mm)
Hauteur / Height / Höhe (Minimum 1000mm / Maximum 2000mm)

Portillon
Pedestrian Gate / Einzeltor

Largeur / Width / Breite (Minimum 800mm / Maximum 1500mm)
Hauteur / Height / Höhe (Minimum 1000mm / Maximum 2000mm)



Portail Battant / Swing Gate / Doppeltor
CL42

Portail Coulissant / Sliding Gate / Schiebetor
CL42

DIMENSIONS
Dimensions / Maße

Portail Battant et Coulissant
Swinging and Sliding Gates / Doppeltor und Schiebetor

Largeur / Width / Breite (Minimum 2500mm / Maximum 5000mm)
Hauteur / Height / Höhe (Minimum 1000mm / Maximum 2000mm)

CL44

CL43

CL45



CARACTÉRISTIQUES
Features / Eigenschaften



TRAVERSE RENFORCÉE POUR MOTORISATION
REINFORCED TRAVERSE FOR MOTORIZATION
VERSTÄRKTE PROFIL FÜR MOTOREINBAU



TUBE 70mm
TUBE 70mm
ROHR 70mm



LAME 100mm
BLADE 100mm
LAMELLE 100mm

POSSIBILITÉS
Options / Optionen



SUR MESURE
BESPOKE
MAßANFERTIGUNG



COULISSANT 2 VANTAUX
2 LEAVES SLIDING GATE
ZWEI FLÜGEL SCHIEBETOR



Portail Battant / Swing Gate / Doppeltor
CL44



Portillon / Pedestrian Gate / Einzeltor
CL44



Clôture / Fence / Zaun
AG12



Portail Couissant / Sliding Gate / Schiebetor
CL44



Portail Battant / Swing Gate / Doppeltor
CL43



Portail Couissant / Sliding Gate / Schiebetor
CL43

CL44 / CL43 / CL45:
OPTIONS REEMPLISSAGE
Infill Options / Fülloptionen



Portail Battant et Couissant
Swinging and Sliding Gates / Doppeltor und Schiebetor

DIMENSIONS
Dimensions / Maße

Largeur / Width / Breite (Minimum 3000mm / Maximum 5000mm)
Hauteur / Height / Höhe (Minimum 1000mm / Maximum 2200mm)

Portillon
Pedestrian Gate / Einzeltor

Largeur / Width / Breite (Minimum 800mm / Maximum 1500mm)
Hauteur / Height / Höhe (Minimum 1000mm / Maximum 2200mm)



Portail Battant / Swing Gate / Doppeltor
CL45



Portail Couissant / Sliding Gate / Schiebetor
CL45

DIMENSIONS
Dimensions / Maße

Portail Battant et Couissant
Swinging and Sliding Gates / Doppeltor und Schiebetor
Largeur / Width / Breite (Minimum 2500mm / Maximum 5000mm)
Hauteur / Height / Höhe (Minimum 1000mm / Maximum 2200mm)

CL46

CL47



CLASSIC

CARACTÉRISTIQUES
Features / Eigenschaften



**TRAVERSE RENFORCÉE
POUR MOTORISATION**
REINFORCED TRAVERSE FOR MOTORIZATION
VERSTÄRKTES PROFIL FÜR MOTOREINBAU



TUBE 70mm
TUBE 70mm
ROHR 70mm



LAME 100mm
BLADE 100mm
LAMELLE 100mm

POSSIBILITÉS
Options / Optionen



SUR MESURE
BESPOKE
MAßANFERTIGUNG



COULISSANT 2 VANTAUX
2 LEAVES SLIDING GATE
ZWEI FLÜGEL SCHIEBETOR



Portail Battant / Swing Gate / Doppeltor
CL46

Portillon / Pedestrian Gate / Einzeltor
CL46

Portail Coulissant / Sliding Gate / Schiebetor
CL46



Portail Battant / Swing Gate / Doppeltor
CL47

Portail Coulissant / Sliding Gate / Schiebetor
CL47



Portail Battant et Coulissant
Swinging and Sliding Gates / Doppeltor und Schiebetor

DIMENSIONS
Dimensions / Maße
Largeur / Width / Breite (Minimum 3000mm / Maximum 5000mm)
Hauteur / Height / Höhe (Minimum 1000mm / Maximum 2000mm)

Portillon
Pedestrian Gate / Einzeltor

Largeur / Width / Breite (Minimum 800mm / Maximum 1500mm)
Hauteur / Height / Höhe (Minimum 1000mm / Maximum 2000mm)

CL48

CL49



CARACTÉRISTIQUES
Features / Eigenschaften



**TRAVERSE RENFORCÉE
POUR MOTORISATION**
REINFORCED TRAVERSE FOR MOTORIZATION
VERSTÄRKTES PROFIL FÜR MOTOREINBAU



TUBE 70mm
TUBE 70mm
ROHR 70mm



LAME 100mm
BLADE 100mm
LAMELLE 100mm

POSSIBILITÉS
Options / Optionen



SUR MESURE
BESPOKE
MAßANFERTIGUNG



COULISSANT 2 VANTAUX
2 LEAVES SLIDING GATE
ZWEI FLÜGEL SCHIEBETOR



Portail Battant / Swing Gate / Doppeltor
CL48

Portillon / Pedestrian Gate / Einzeltor
CL48

Portail Coulissant / Sliding Gate / Schiebetor
CL48

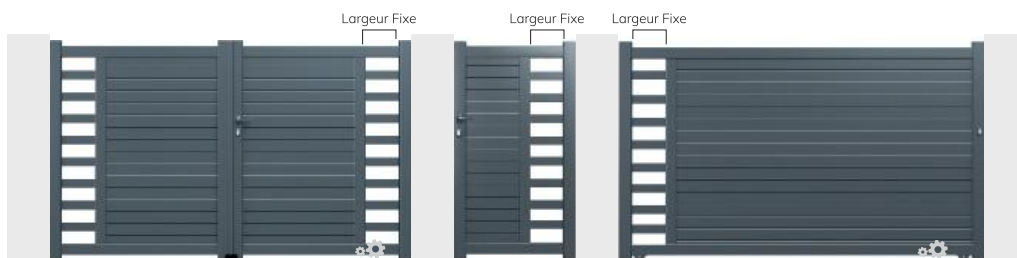

Portail Battant / Swing Gate / Doppeltor
CL49

Portillon
Pedestrian Gate / Einzeltor
CL49

Portail Coulissant / Sliding Gate / Schiebetor
CL49



Portail Battant et Coulissant
Swinging and Sliding Gates / Doppeltor und Schiebetor

DIMENSIONS
Dimensions / Maße

Largeur / Width / Breite (Minimum 2500mm / Maximum 5000mm)
Hauteur / Height / Höhe (Minimum 1000mm / Maximum 2000mm)

Portillon
Pedestrian Gate / Einzeltor

Largeur / Width / Breite (Minimum 800mm / Maximum 1500mm)
Hauteur / Height / Höhe (Minimum 1000mm / Maximum 2000mm)

CLASSIC







TRADITION



DESCRIPTION

La gamme Tradition, en aluminium, reprend l'esthétisme du portail classique en fer, étant ainsi bien adaptée aux styles de l'architecture traditionnelle.

The Tradition range takes up the aesthetics of the classic iron made gate, therefore being well suited to the styles of traditional architecture.

PORTAILS GATES / TORE

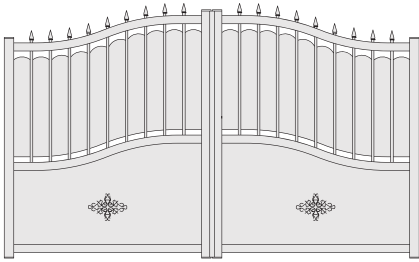

TR01A
p. 84

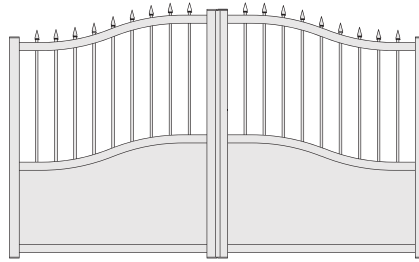

TR01B
p. 84

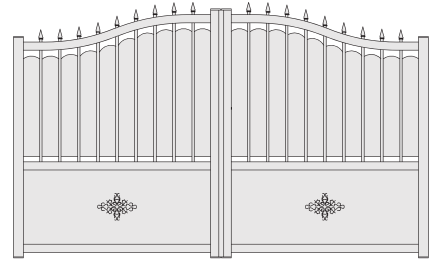

TR02A
p. 85

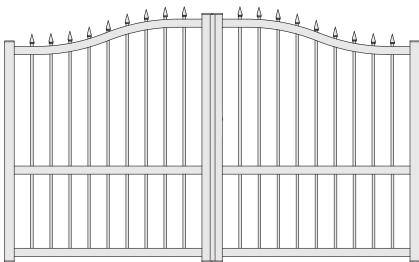

TR02C
p. 85

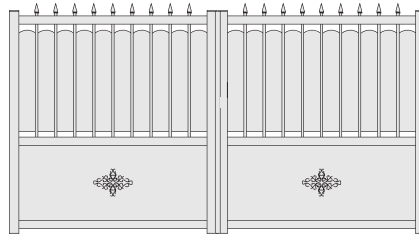

TR03A
p. 87

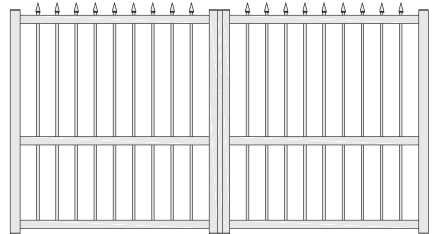

TR03C
p. 87

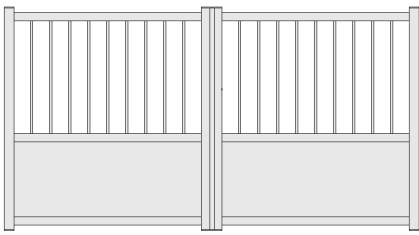

TR05
p. 88

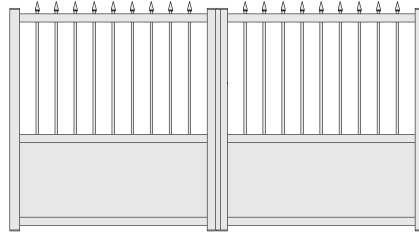

TR03B
p. 88

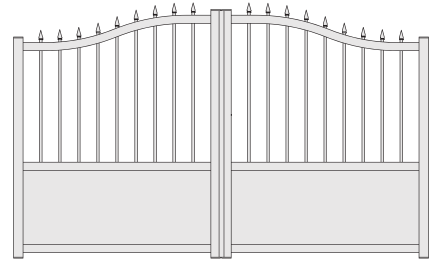

TR02B
p. 89

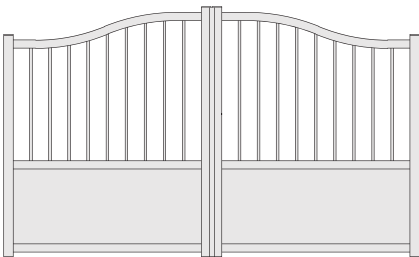

TR04
p. 89

TR01A

TR01B



TRADITION

CARACTÉRISTIQUES
Features / Eigenschaften



**TRAVERSE RENFORCÉE
POUR MOTORISATION**
REINFORCED TRAVERSE FOR MOTORIZATION
VERSTÄRKTES PROFIL FÜR MOTOREINBAU



TUBE 18mm
TUBE 18mm
ROHR 18mm



TÔLE
ALUMINUM SHEET
ALUMINIUMBLATT

POSSIBILITÉS
Options / Optionen



SUR MESURE
BESPOKE
MAßANFERTIGUNG



Portail Battant et Coulissant
Swinging and Sliding Gates / Doppeltor und Schiebetor

DIMENSIONS
Dimensions / Maße

Largeur / Width / Breite (Minimum 2500mm / Maximum 5000mm)
Hauteur / Height / Höhe (Minimum 1000mm / Maximum 2000mm)

Portillon
Pedestrian Gate / Einzeltor

Largeur / Width / Breite (Minimum 800mm / Maximum 1500mm)
Hauteur / Height / Höhe (Minimum 1000mm / Maximum 2000mm)

TR02A

TR02C



CARACTÉRISTIQUES
Features / Eigenschaften



**TRAVERSE RENFORCÉE
POUR MOTORISATION**
REINFORCED TRAVERSE FOR MOTORIZATION
VERSTÄRKTE PROFIL FÜR MOTOREINBAU



TUBE 18mm
TUBE 18mm
ROHR 18mm



TÔLE
ALUMINIUM SHEET
ALUMINIUMBLATT

POSSIBILITÉS
Options / Optionen



SUR MESURE
BESPOKE
MAßANFERTIGUNG

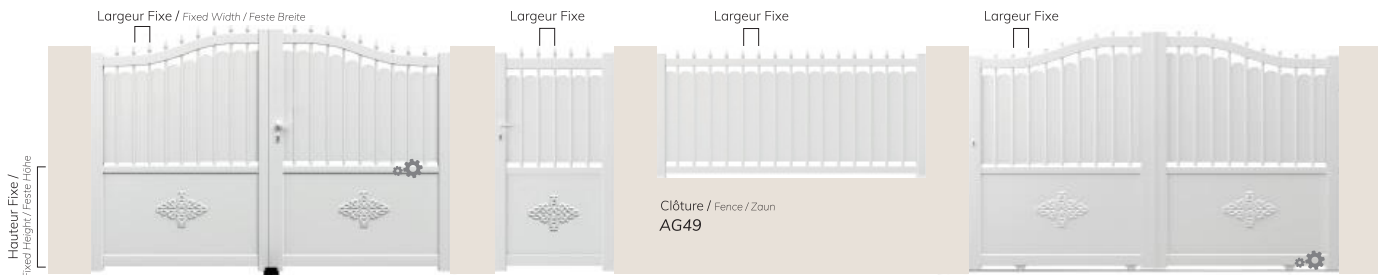

Portail Battant / Swing Gate / Doppeltor
TR02A

Portillon / Pedestrian Gate / Einzeltor
TR02A

Portail Coulissant / Sliding Gate / Schiebetor
TR02A

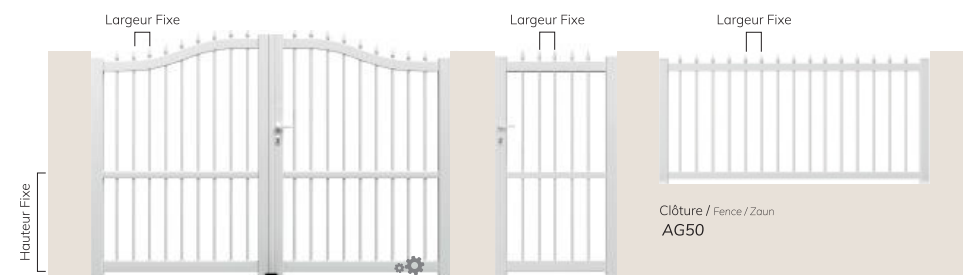

Portail Battant / Swing Gate / Doppeltor
TR02C

Portillon / Pedestrian Gate / Einzeltor
TR02C



Portail Battant et Coulissant
Swinging and Sliding Gates / Doppeltor und Schiebetor

DIMENSIONS
Dimensions / Maße
Largeur / Width / Breite (Minimum 2500mm / Maximum 5000mm)
Hauteur / Height / Höhe (Minimum 1000mm / Maximum 2000mm)

Portillon
Pedestrian Gate / Einzeltor

Largeur / Width / Breite (Minimum 800mm / Maximum 1500mm)
Hauteur / Height / Höhe (Minimum 1000mm / Maximum 2000mm)

**OPTION
ROSACE ET
POINTES DORÉES**

**OPTION: GOLDEN
FINIALS AND ROSETTE**



TR03A

TR03C



CARACTÉRISTIQUES
Features / Eigenschaften



**TRAVERSE RENFORCÉE
POUR MOTORISATION**
REINFORCED TRAVERSE FOR MOTORIZATION
VERSTÄRKTE PROFIL FÜR MOTOREINBAU



TUBE 18mm
TUBE 18mm
ROHR 18mm



TÔLE
ALUMINIUM SHEET
ALUMINIUMBLATT

POSSIBILITÉS
Options / Optionen



SUR MESURE
BESPOKE
MAßANFERTIGUNG

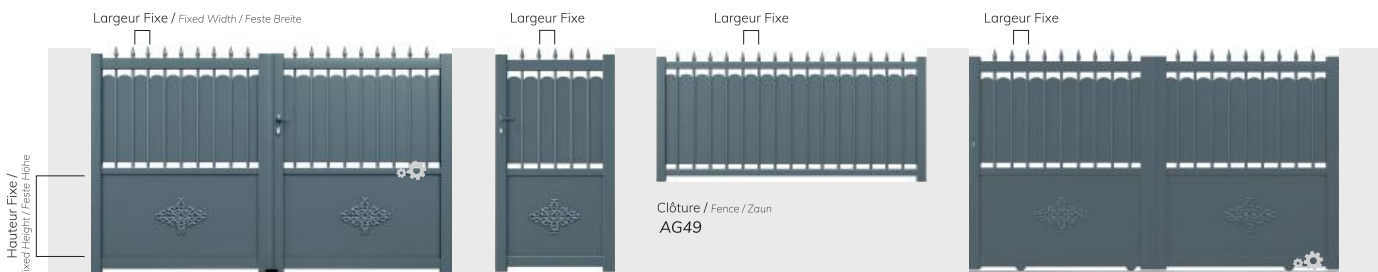

Largeur Fixe / Fixed Width / Feste Breite

Largeur Fixe

Largeur Fixe

Largeur Fixe

Hauteur Fixe /
Fixed Height / Feste Höhe

Clôture / Fence / Zaun
AG49

Portail Battant / Swing Gate / Doppeltor
TR03A

Portillon / Pedestrian Gate / Einzeltor
TR03A

Portail Coulissant / Sliding Gate / Schiebetor
TR03A

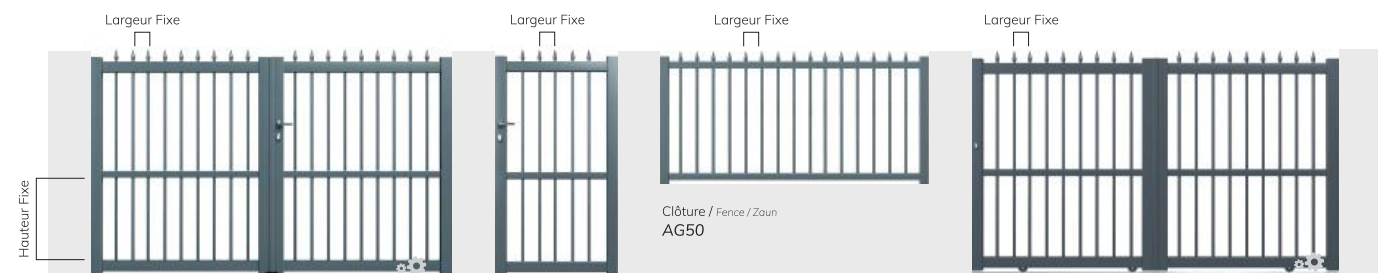

Largeur Fixe

Largeur Fixe

Largeur Fixe

Largeur Fixe

Hauteur Fixe

Clôture / Fence / Zaun
AG50

Portail Battant / Swing Gate / Doppeltor
TR03C

Portillon / Pedestrian Gate / Einzeltor
TR03C

Portail Coulissant / Sliding Gate / Schiebetor
TR03C

DIMENSIONS
Dimensions / Maße

Portail Battant et Coulissant
Swinging and Sliding Gates / Doppeltor und Schiebetor

Largeur / Width / Breite (Minimum 2500mm / Maximum 5000mm)
Hauteur / Height / Höhe (Minimum 1000mm / Maximum 2000mm)

Portillon
Pedestrian Gate / Einzeltor

Largeur / Width / Breite (Minimum 800mm / Maximum 1500mm)
Hauteur / Height / Höhe (Minimum 1000mm / Maximum 2000mm)



TR05

TR03B



TRADITION

CARACTÉRISTIQUES
Features / Eigenschaften



**TRAVERSE RENFORCÉE
POUR MOTORISATION**
REINFORCED TRAVERSE FOR MOTORIZATION
VERSTÄRKTES PROFIL FÜR MOTOREINBAU



TUBE 18mm
TUBE 18mm
ROHR 18mm



TÔLE
ALUMINUM SHEET
ALUMINIUMBLATT

POSSIBILITÉS
Options / Optionen



SUR MESURE
BESPOKE
MAßANFERTIGUNG

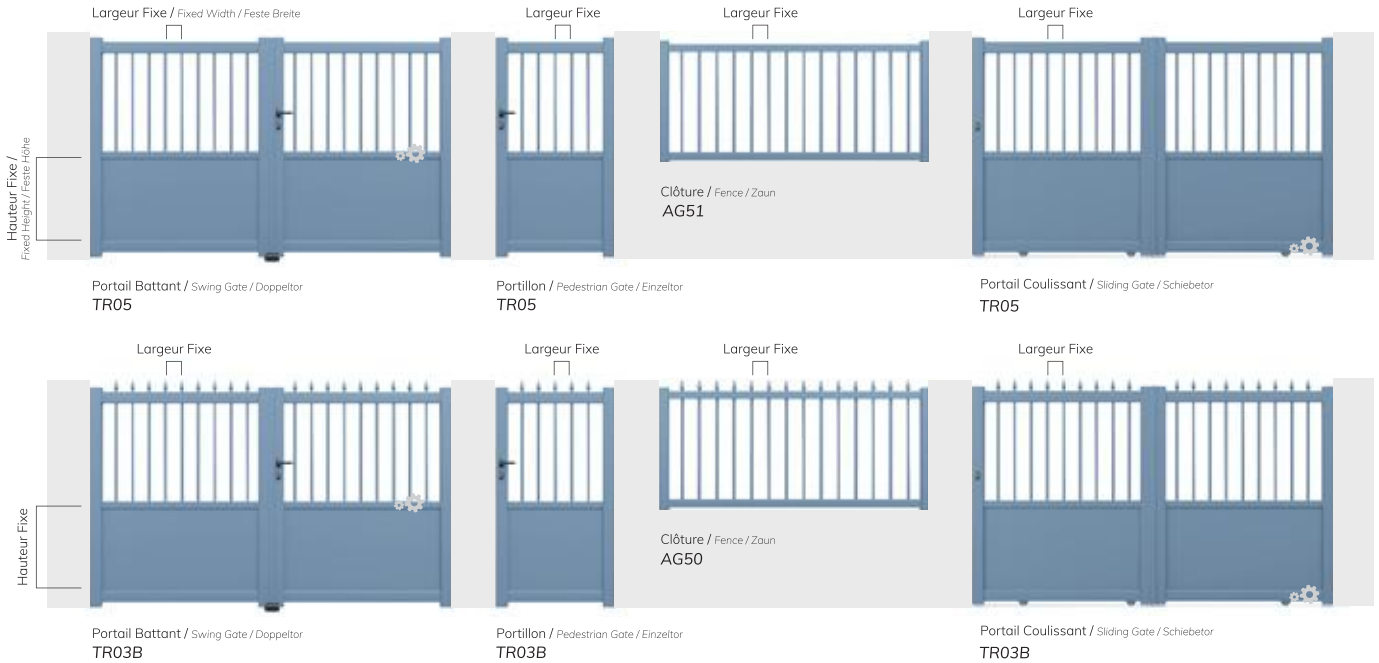

DIMENSIONS
Dimensions / Maße

Portail Battant et Coulissant
Swinging and Sliding Gates / Doppeltor und Schiebetor

Largeur / Width / Breite (Minimum 2500mm / Maximum 5000mm)
Hauteur / Height / Höhe (Minimum 1000mm / Maximum 2000mm)

Portillon
Pedestrian Gate / Einzeltor

Largeur / Width / Breite (Minimum 800mm / Maximum 1500mm)
Hauteur / Height / Höhe (Minimum 1000mm / Maximum 2000mm)



TR02B

TR04



CARACTÉRISTIQUES
Features / Eigenschaften



**TRAVERSE RENFORCÉE
POUR MOTORISATION**
REINFORCED TRAVERSE FOR MOTORIZATION
VERSTÄRKTES PROFIL FÜR MOTOREINBAU



TUBE 18mm
TUBE 18mm
ROHR 18mm



TÔLE
ALUMINIUM SHEET
ALUMINIUMBLATT

POSSIBILITÉS
Options / Optionen



SUR MESURE
BESPOKE
MAßANFERTIGUNG



Portail Battant / Swing Gate / Doppeltor
TR02B

Portillon / Pedestrian Gate / Einzeltor
TR02B

Clôture / Fence / Zaun
AG50



Portail Battant / Swing Gate / Doppeltor
TR04

Portillon / Pedestrian Gate / Einzeltor
TR04

Clôture / Fence / Zaun
AG51



Portail Battant
Swinging Gate / Doppeltor

DIMENSIONS
Dimensions / Maße

Largeur / Width / Breite (Minimum 2500mm / Maximum 5000mm)
Hauteur / Height / Höhe (Minimum 1000mm / Maximum 2000mm)

Portillon
Pedestrian Gate / Einzeltor

Largeur / Width / Breite (Minimum 800mm / Maximum 1500mm)
Hauteur / Height / Höhe (Minimum 1000mm / Maximum 2000mm)



A photograph of a person wearing a light-colored sweater with dark horizontal stripes, leaning against a modern, multi-layered structure. The structure consists of a dark grey vertical metal post on the left, a horizontal wooden panel in the middle, and a dark grey perforated metal panel at the bottom. The background is a bright, out-of-focus outdoor setting with a building and a clear sky. The word "MODERN" is written in white, uppercase, sans-serif font inside a white rectangular box that is semi-transparent, allowing the background image to be visible through it.

MODERN

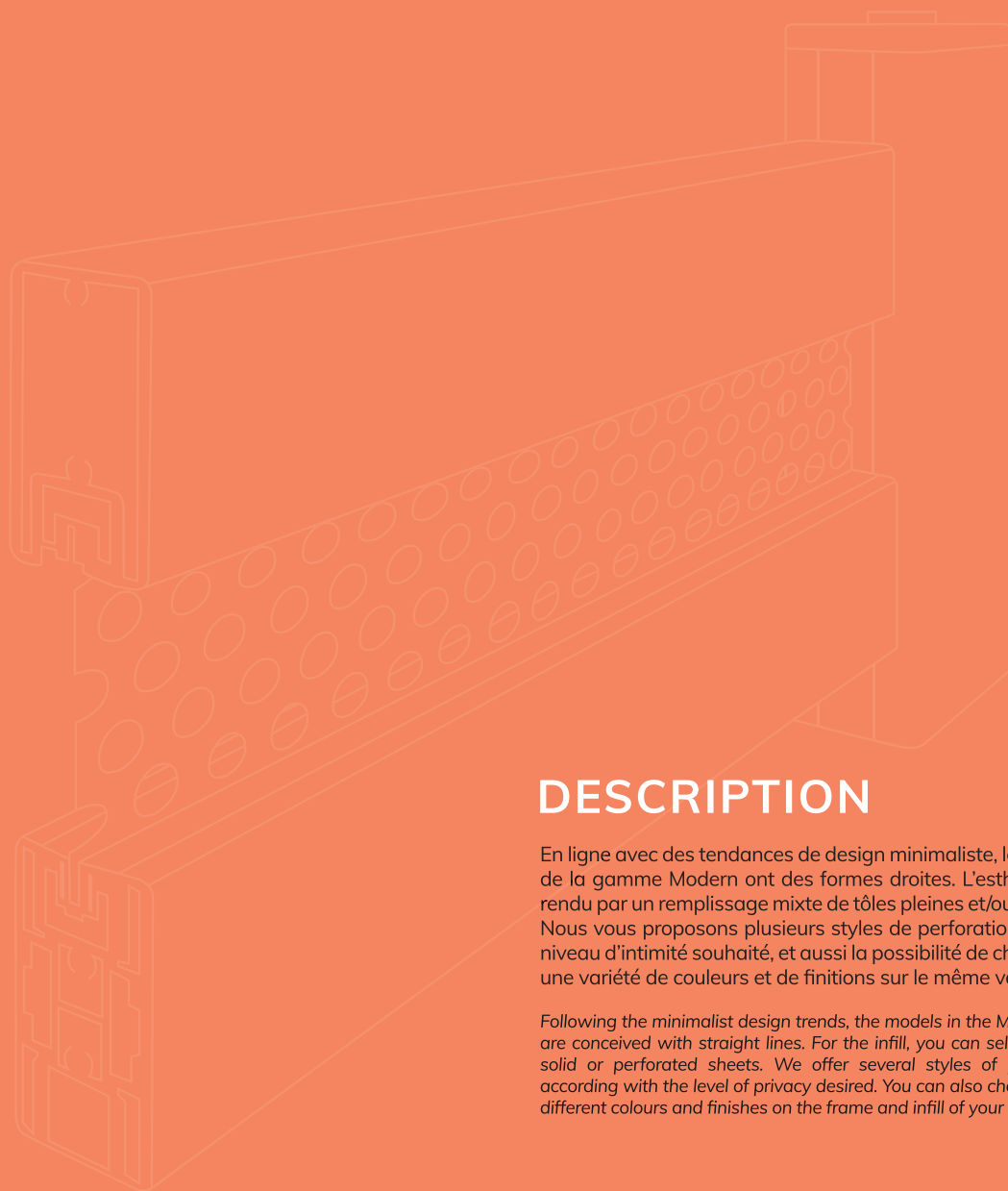

DESCRIPTION

En ligne avec des tendances de design minimaliste, les modèles de la gamme Modern ont des formes droites. L'esthétisme est rendu par un remplissage mixte de tôles pleines et/ou perforées. Nous vous proposons plusieurs styles de perforations, selon le niveau d'intimité souhaité, et aussi la possibilité de choisir parmi une variété de couleurs et de finitions sur le même vantail.

Following the minimalist design trends, the models in the Modern range are conceived with straight lines. For the infill, you can select between solid or perforated sheets. We offer several styles of perforations, according with the level of privacy desired. You can also choose to have different colours and finishes on the frame and infill of your gate.

PORTAILS GATES / TORE

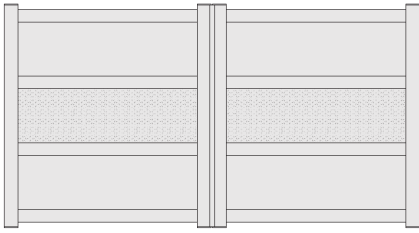

MD01A
p. 94

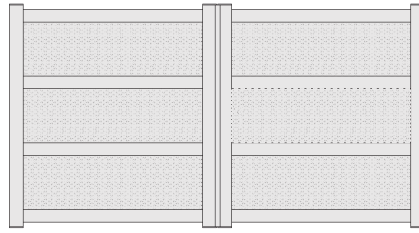

MD01B
p. 95

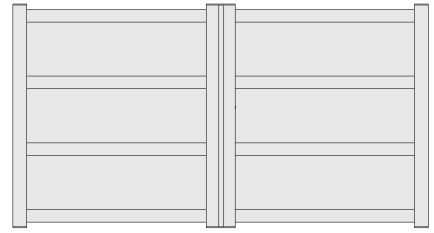

MD01C
p. 96

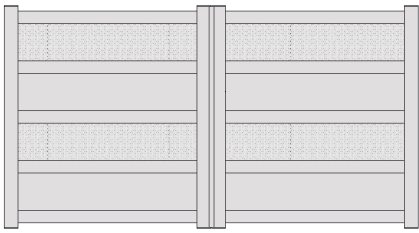

MD02A
p. 97

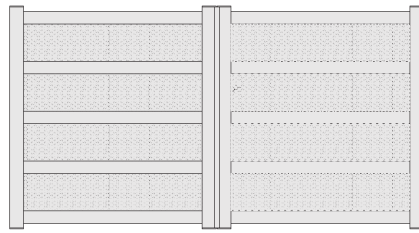

MD02B
p. 98

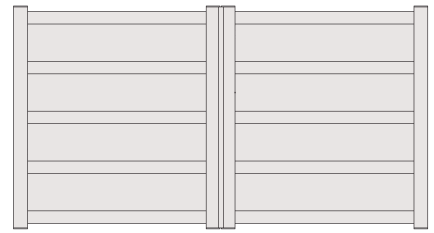

MD02C
p. 99

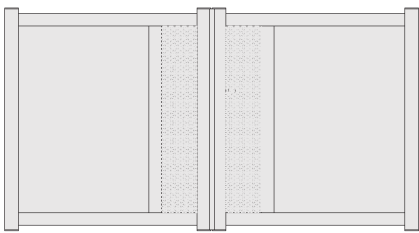

MD03
p. 101

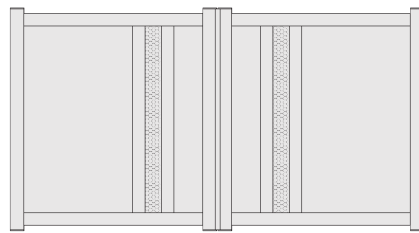

MD04
p. 102

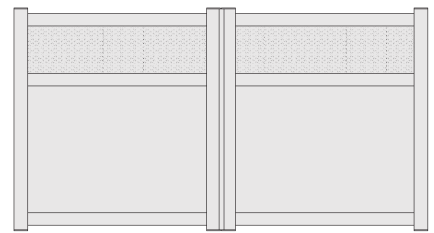

MD05
p. 103

MD01A



CARACTÉRISTIQUES
Features / Eigenschaften



**TRAVERSE RENFORCÉE
POUR MOTORISATION**
REINFORCED TRAVERSE FOR MOTORIZATION
VERSTÄRKTES PROFIL FÜR MOTOREINBAU



TÔLE
ALUMINUM SHEET
ALUMINIUMBLATT



TÔLE PERFORÉE
PERFORATED ALUMINUM SHEET
PERFORIERTES ALUMINIUMBLATT

POSSIBILITÉS
Options / Optionen



SUR MESURE
BESPOKE
MAßANFERTIGUNG



COULISSANT 2 VANTAUX
2 LEAVES SLIDING GATE
ZWEI FLÜGEL SCHIEBETOR

MODERN



Portail Battant / Swing Gate / Doppeltor
MD01A

Portillon / Pedestrian Gate / Einzeltor
MD01A

Portail Coulissant / Sliding Gate / Schiebetor
MD01A

Clôture / Fence / Zaun
AG28

CHOIX TÔLE PERFORÉE
Choose Perforated Aluminum Sheet / Wählen
Perforiertes Aluminiumblatt



**OPTION
TON BOIS**
OPTION WOOD FINISHING
OPTION HOLZDEKOR



Portail Battant et Coulissant
Swinging and Sliding Gates / Doppeltor und Schiebetor

DIMENSIONS
Dimensions / Maße
Largeur / Width / Breite (Minimum 2500mm / Maximum 4000mm)
Hauteur / Height / Höhe (Minimum 1200mm / Maximum 2000mm)

Portillon
Pedestrian Gate / Einzeltor

Largeur / Width / Breite (Minimum 800mm / Maximum 1500mm)
Hauteur / Height / Höhe (Minimum 1200mm / Maximum 2000mm)



CARACTÉRISTIQUES
Features / Eigenschaften



**TRAVERSE RENFORCÉE
POUR MOTORISATION**
REINFORCED TRAVERSE FOR MOTORIZATION
VERSTÄRKTE PROFIL FÜR MOTOREINBAU



TÔLE PERFORÉE
PERFORATED ALUMINUM SHEET
PERFORIERTES ALUMINIUMBLATT

POSSIBILITÉS
Options / Optionen



SUR MESURE
BESPOKE
MAßANFERTIGUNG



COULISSANT 2 VANTAUX
2 LEAVES SLIDING GATE
ZWEI FLÜGEL SCHIEBETOR



Portail Battant / Swing Gate / Doppeltor
MD01B

Portillon / Pedestrian Gate / Einzeltor
MD01B

Portail Couissant / Sliding Gate / Schiebetor
MD01B

CHOIX TÔLE PERFORÉE
Choose Perforated Aluminum Sheet / Wählen
Perforiertes Aluminiumblatt



Portail Battant et Couissant
Swinging and Sliding Gates / Doppeltor und Schiebetor

DIMENSIONS
Dimensions / Maße
Largeur / Width / Breite (Minimum 2500mm / Maximum 4000mm)
Hauteur / Height / Höhe (Minimum 1200mm / Maximum 2000mm)

Portillon
Pedestrian Gate / Einzeltor

Largeur / Width / Breite (Minimum 800mm / Maximum 1500mm)
Hauteur / Height / Höhe (Minimum 1200mm / Maximum 2000mm)

MD01C



MODERN

CARACTÉRISTIQUES
Features / Eigenschaften



**TRAVERSE RENFORCÉE
POUR MOTORISATION**
REINFORCED TRAVERSE FOR MOTORIZATION
VERSTÄRKTE PROFIL FÜR MOTOREINBAU



TÔLE
ALUMINUM SHEET
ALUMINIUMBLATT

POSSIBILITÉS
Options / Optionen



SUR MESURE
BESPOKE
MAßANFERTIGUNG



COULISSANT 2 VANTAUX
2 LEAVES SLIDING GATE
ZWEI FLÜGEL SCHIEBETOR



Portail Battant / Swing Gate / Doppeltor
MD01C

Portillon / Pedestrian Gate / Einzeltor
MD01C

Portail Couissant / Sliding Gate / Schiebetor
MD01C

Clôture / Fence / Zaun
AG23



RAL 7016 STR

RAL 3004 STR

**DISPONIBLE EN
BI-COULEUR**

AVAILABLE IN BI-COLOUR
ZWEIFARBIG VERFÜGBAR

Autres couleurs disponibles / Other colours
available / Andere Farben erhältlich



Portail Battant et Couissant
Swinging and Sliding Gates / Doppeltor und Schiebetor

DIMENSIONS
Dimensions / Maße
Largeur / Width / Breite (Minimum 2500mm / Maximum 4000mm)
Hauteur / Height / Höhe (Minimum 1200mm / Maximum 2000mm)

Portillon
Pedestrian Gate / Einzeltor

Largeur / Width / Breite (Minimum 800mm / Maximum 1500mm)
Hauteur / Height / Höhe (Minimum 1200mm / Maximum 2000mm)

MD02A



CARACTÉRISTIQUES
Features / Eigenschaften



**TRAVERSE RENFORCÉE
POUR MOTORISATION**
REINFORCED TRAVERSE FOR MOTORIZATION
VERSTÄRKTE PROFIL FÜR MOTOREINBAU



TÔLE
ALUMINUM SHEET
ALUMINIUMBLATT



TÔLE PERFORÉE
PERFORATED ALUMINUM SHEET
PERFORIERTES ALUMINIUMBLATT

POSSIBILITÉS
Options / Optionen



SUR MESURE
BESPOKE
MAßANFERTIGUNG



COULISSANT 2 VANTAUX
2 LEAVES SLIDING GATE
ZWEI FLÜGEL SCHIEBETOR

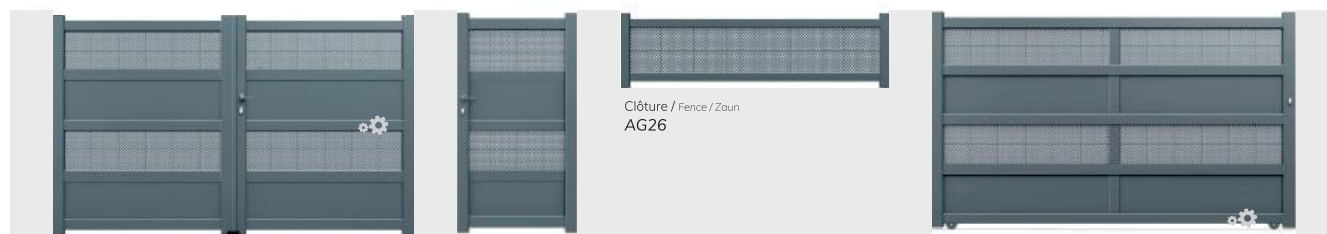

Portail Battant / Swing Gate / Doppeltor
MD02A

Portillon / Pedestrian Gate / Einzeltor
MD02A

Portail Coulissant / Sliding Gate / Schiebetor
MD02A

CHOIX TÔLE PERFORÉE
Choose Perforated Aluminum Sheet / Wählen
Perforiertes Aluminiumblatt



Portail Battant et Coulissant
Swinging and Sliding Gates / Doppeltor und Schiebetor

DIMENSIONS
Dimensions / Maße
Largeur / Width / Breite (Minimum 2500mm / Maximum 4000mm)
Hauteur / Height / Höhe (Minimum 1400mm / Maximum 2000mm)

Portillon
Pedestrian Gate / Einzeltor

Largeur / Width / Breite (Minimum 800mm / Maximum 1500mm)
Hauteur / Height / Höhe (Minimum 1400mm / Maximum 2000mm)

MODERN



MD02B



MODERN

CARACTÉRISTIQUES
Features / Eigenschaften



**TRAVERSE RENFORCÉE
POUR MOTORISATION**
REINFORCED TRAVERSE FOR MOTORIZATION
VERSTÄRKTE PROFIL FÜR MOTOREINBAU



TÔLE PERFORÉE
PERFORATED ALUMINUM SHEET
PERFORIERTES ALUMINIUMBLATT

POSSIBILITÉS
Options / Optionen



SUR MESURE
BESPOKE
MAßANFERTIGUNG



COULISSANT 2 VANTAUX
2 LEAVES SLIDING GATE
ZWEI FLÜGEL SCHIEBETOR



Portail Battant / Swing Gate / Doppeltor
MD02B

Portillon / Pedestrian Gate / Einzeltor
MD02B

Portail Couissant / Sliding Gate / Schiebetor
MD02B

Clôture / Fence / Zaun
AG26

CHOIX TÔLE PERFORÉE
Choose Perforated Aluminum Sheet / Wählen
Perforiertes Aluminiumblatt



Portail Battant et Couissant
Swinging and Sliding Gates / Doppeltor und Schiebetor

DIMENSIONS
Dimensions / Maße
Largeur / Width / Breite (Minimum 2500mm / Maximum 4000mm)
Hauteur / Height / Höhe (Minimum 1400mm / Maximum 2000mm)

Portillon
Pedestrian Gate / Einzeltor

Largeur / Width / Breite (Minimum 800mm / Maximum 1500mm)
Hauteur / Height / Höhe (Minimum 1400mm / Maximum 2000mm)



CARACTÉRISTIQUES
Features / Eigenschaften



**TRAVERSE RENFORCÉE
POUR MOTORISATION**
REINFORCED TRAVERSE FOR MOTORIZATION
VERSTÄRKTE PROFIL FÜR MOTOREINBAU



TÔLE
ALUMINUM SHEET
ALUMINIUMBLATT

POSSIBILITÉS
Options / Optionen



SUR MESURE
BESPOKE
MAßANFERTIGUNG



COULISSANT 2 VANTAUX
2 LEAVES SLIDING GATE
ZWEI FLÜGEL SCHIEBETOR



Portail Battant / Swing Gate / Doppeltor
MD02C

Portillon / Pedestrian Gate / Einzeltor
MD02C

Portail Couissant / Sliding Gate / Schiebetor
MD02C

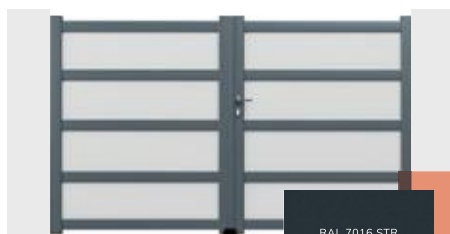

RAL 7016 STR

RAL 9006 STR

**DISPONIBLE EN
BI-COULEUR**

AVAILABLE IN BI-COLOUR
ZWEIFARBIG VERFÜGBAR

Autres couleurs disponibles / Other colours
available / Andere Farben erhältlich



Portail Battant et Couissant
Swinging and Sliding Gates / Doppeltor und Schiebetor

DIMENSIONS
Dimensions / Maße
Largeur / Width / Breite (Minimum 2500mm / Maximum 4000mm)
Hauteur / Height / Höhe (Minimum 1400mm / Maximum 2000mm)

Portillon
Pedestrian Gate / Einzeltor

Largeur / Width / Breite (Minimum 800mm / Maximum 1500mm)
Hauteur / Height / Höhe (Minimum 1400mm / Maximum 2000mm)

**TÔLE PERFORÉE
AUTRES COULEURS
EN OPTION**

*PERFORATED ALUMINUM
SHEET WITH OPTIONAL
COLOURS*





CARACTÉRISTIQUES
Features / Eigenschaften



TRAVERSE RENFORCÉE POUR MOTORISATION
REINFORCED TRAVERSE FOR MOTORIZATION
VERSTÄRKTE PROFIL FÜR MOTOREINBAU



TÔLE
ALUMINIUM SHEET
ALUMINIUMBLATT



TÔLE PERFORÉE
PERFORATED ALUMINIUM SHEET
PERFORIERTES ALUMINIUMBLATT

POSSIBILITÉS
Options / Optionen



SUR MESURE
BESPOKE
MAßANFERTIGUNG



COULISSANT 2 VANTAUX
2 LEAVES SLIDING GATE
ZWEI FLÜGEL SCHIEBETOR



Portail Battant / Swing Gate / Doppeltor
MD03

Portillon / Pedestrian Gate / Einzeltor
MD03

Portail Coulissant / Sliding Gate / Schiebetor
MD03

CHOIX TÔLE PERFORÉE
Choose Perforated Aluminum Sheet / Wählen
Perforiertes Aluminiumblatt



Portail Battant et Coulissant
Swinging and Sliding Gates / Doppeltor und Schiebetor

DIMENSIONS
Dimensions / Maße
Largeur / Width / Breite (Minimum 2500mm / Maximum 4000mm)
Hauteur / Height / Höhe (Minimum 1000mm / Maximum 2000mm)

Portillon
Pedestrian Gate / Einzeltor

Largeur / Width / Breite (Minimum 800mm / Maximum 1500mm)
Hauteur / Height / Höhe (Minimum 1000mm / Maximum 2000mm)

MD04



MODERN

CARACTÉRISTIQUES
Features / Eigenschaften



TRAVERSE RENFORCÉE POUR MOTORISATION
REINFORCED TRAVERSE FOR MOTORIZATION
VERSTÄRKTES PROFIL FÜR MOTOREINBAU



TÔLE
ALUMINUM SHEET
ALUMINIUMBLATT



TÔLE PERFORÉE
PERFORATED ALUMINUM SHEET
PERFORIERTES ALUMINIUMBLATT

POSSIBILITÉS
Options / Optionen



SUR MESURE
BESPOKE
MAßANFERTIGUNG



COULISSANT 2 VANTAUX
2 LEAVES SLIDING GATE
ZWEI FLÜGEL SCHIEBETOR

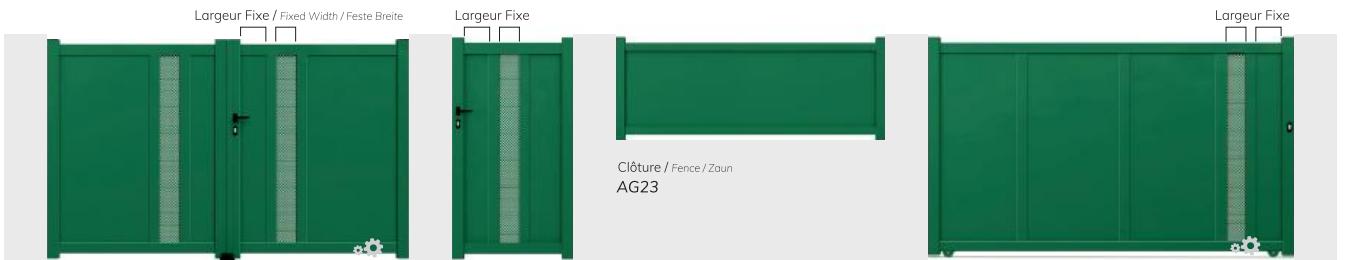

Portail Battant / Swing Gate / Doppeltor
MD04

Portillon / Pedestrian Gate / Einzeltor
MD04

Portail Couissant / Sliding Gate / Schiebetor
MD04

Clôture / Fence / Zaun
AG23

CHOIX TÔLE PERFORÉE
Choose Perforated Aluminum Sheet / Wählen
Perforiertes Aluminiumblatt

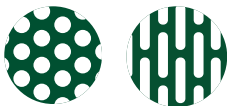

Portail Battant et Couissant
Swinging and Sliding Gates / Doppeltor und Schiebetor

DIMENSIONS
Dimensions / Maße
Largeur / Width / Breite (Minimum 2500mm / Maximum 4000mm)
Hauteur / Height / Höhe (Minimum 1000mm / Maximum 2000mm)

Portillon
Pedestrian Gate / Einzeltor

Largeur / Width / Breite (Minimum 800mm / Maximum 1500mm)
Hauteur / Height / Höhe (Minimum 1000mm / Maximum 2000mm)



CARACTÉRISTIQUES
Features / Eigenschaften



**TRAVERSE RENFORCÉE
POUR MOTORISATION**
REINFORCED TRAVERSE FOR MOTORIZATION
VERSTÄRKTE PROFIL FÜR MOTOREINBAU



TÔLE
ALUMINUM SHEET
ALUMINIUMBLATT



TÔLE PERFORÉE
PERFORATED ALUMINUM SHEET
PERFORIERTES ALUMINIUMBLATT

POSSIBILITÉS
Options / Optionen



SUR MESURE
BESPOKE
MAßANFERTIGUNG



COULISSANT 2 VANTAUX
2 LEAVES SLIDING GATE
ZWEI FLÜGEL SCHIEBETOR

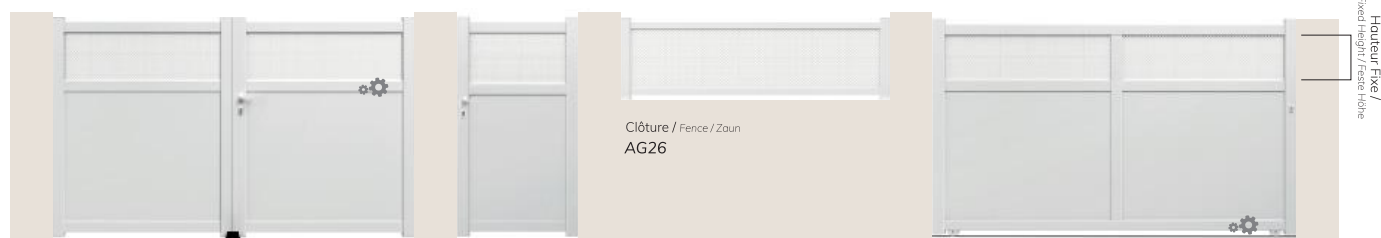

Portail Battant / Swing Gate / Doppeltor
MD05

Portillon / Pedestrian Gate / Einzeltor
MD05

Portail Couissant / Sliding Gate / Schiebetor
MD05

Ciôture / Fence / Zaun
AG26

Hauteur Fixe /
Fixed Height / Feste Höhe

CHOIX TÔLE PERFORÉE
Choose Perforated Aluminum Sheet / Wählen
Perforiertes Aluminiumblatt



Portail Battant et Couissant
Swinging and Sliding Gates / Doppeltor und Schiebetor

DIMENSIONS
Dimensions / Maße

Largeur / Width / Breite (Minimum 2500mm / Maximum 4000mm)
Hauteur / Height / Höhe (Minimum 1000mm / Maximum 1800mm)

Portillon
Pedestrian Gate / Einzeltor

Largeur / Width / Breite (Minimum 800mm / Maximum 1500mm)
Hauteur / Height / Höhe (Minimum 1000mm / Maximum 1800mm)





DESIGN



DESCRIPTION

La combinaison des matériaux comme le verre et l'alunox, les différentes formes et dimensions, permettent de vous offrir une gamme de produits avec des designs audacieux, modernes et personnalisés. La gamme Design vous offre la possibilité d'être à l'origine de la création du décor de votre portail. Gardengate vous offre aussi, dans la gamme design, la possibilité de coordonner votre portail avec votre porte d'entrée et votre porte sectionnelle de garage. Une solution plus harmonieuse pour votre maison.

The combination of materials such as glass and alunox in different sizes and shapes allows us to offer you a range of products with an audacious, modern and differentiated design. The Design range offers you the chance of being at the origin of the creation of the decoration for your garden gate. You can match your design gate with a front door and a garage door. This creates a more harmonious solution for your house.

PORTAILS GATES / TORE

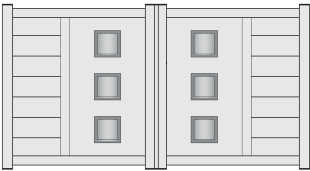

DE03
p. 108

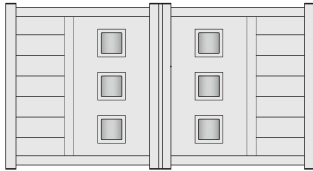

DE07
p. 108

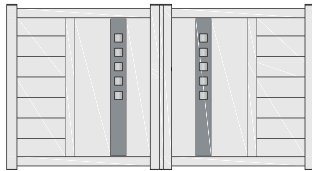

DE06
p. 109

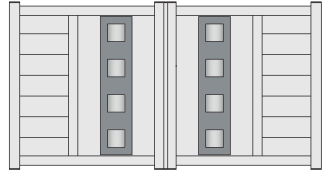

DE14
p. 109

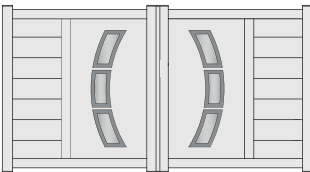

DE19
p. 110

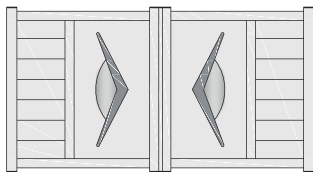

DE26
p. 110



DE24
p. 111



DE21
p. 111

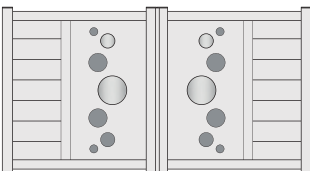

DE02
p. 112



DE22
p. 112

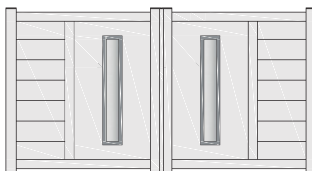

DE17
p. 113

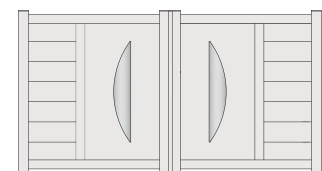

DE23
p. 113

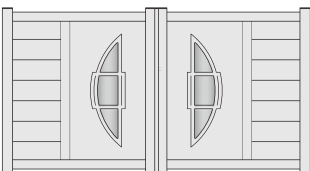

DE04
p. 114

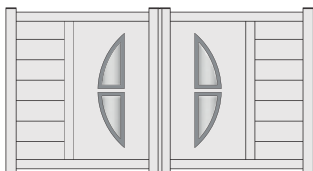

DE16
p. 114

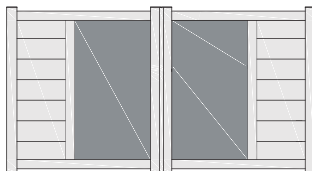

DE12
p. 115

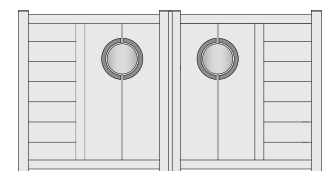

DE25
p. 115

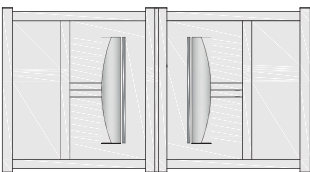

DE13
p. 116



DE01
p. 116



DE27
p. 117



DE15
p. 117

DE03



CARACTÉRISTIQUES
Features / Eigenschaften



**TRAVERSE RENFORCÉE
POUR MOTORISATION**
REINFORCED PROFILE FOR MOTORIZATION
VERSTÄRKTES PROFIL FÜR MOTOREINBAU



LAME 200mm
BLADE 200mm
LAMELLE 200mm



**PANNEAU
DÉCORATIF**
DECORATIVE
PANEL
DEKORATIV
PLATTE



VITRAGE
FROSTED GLASS
MILCHGLAS



ALUNOX

POSSIBILITÉS
Options / Optionen



SUR MESURE
BESPOKE
MAßANFERTIGUNG



COULISSANT 2 VANTAUX
2 LEAVES SLIDING GATE
ZWEI FLÜGEL SCHIEBETOR

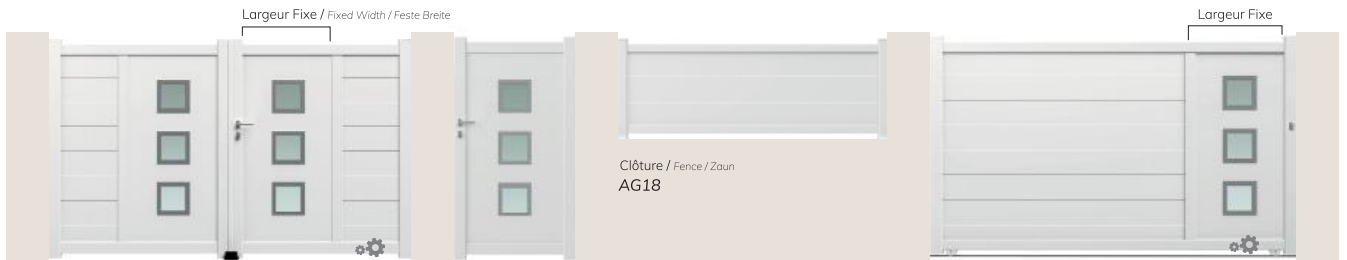

Portail Battant / Swing Gate / Doppeltor
DE03

Portillon / Pedestrian Gate / Einzeltor
DE03

Portail Coulissant / Sliding Gate / Schiebetor
DE03

Clôture / Fence / Zaun
AG18

DESIGN

CARACTÉRISTIQUES
Features / Eigenschaften



**TRAVERSE RENFORCÉE
POUR MOTORISATION**
REINFORCED PROFILE FOR MOTORIZATION
VERSTÄRKTES PROFIL FÜR MOTOREINBAU



LAME 200mm
BLADE 200mm
LAMELLE 200mm



**PANNEAU
DÉCORATIF**
DECORATIVE
PANEL
DEKORATIV
PLATTE



VITRAGE
FROSTED GLASS
MILCHGLAS

POSSIBILITÉS
Options / Optionen



SUR MESURE
BESPOKE
MAßANFERTIGUNG



COULISSANT 2 VANTAUX
2 LEAVES SLIDING GATE
ZWEI FLÜGEL SCHIEBETOR



DE07



Portail Battant / Swing Gate / Doppeltor
DE07

Portillon / Pedestrian Gate / Einzeltor
DE07

Portail Coulissant / Sliding Gate / Schiebetor
DE07

Clôture / Fence / Zaun
AG18

Portail Battant et Coulissant
Swinging and Sliding Gates / Doppeltor und Schiebetor

DIMENSIONS
Dimensions / Maße
Largeur / Width / Breite (Minimum 2500mm / Maximum 5000mm)
Hauteur / Height / Höhe (Minimum 1400mm / Maximum 2200mm)

Portillon
Pedestrian Gate / Einzeltor

Largeur / Width / Breite (Minimum 800mm / Maximum 1400mm)
Hauteur / Height / Höhe (Minimum 1400mm / Maximum 2200mm)

CARACTÉRISTIQUES
Features / Eigenschaften



**TRAVERSE RENFORCÉE
POUR MOTORISATION**

REINFORCED PROFIL FOR MOTORIZATION
VERSTÄRKTE PROFIL FÜR MOTOREINBAU



LAME 200mm
BLADE 200mm
LAMELLE 200mm



**PANNEAU
DÉCORATIF**
DECORATIVE
PANEL
DEKORATIV
PLATTE



VITRAGE
FROSTED GLASS
MILCHGLAS



ALUNOX

POSSIBILITÉS
Options / Optionen



SUR MESURE
BESPOKE
MAßANFERTIGUNG



COULISSANT 2 VANTAUX
2 LEAVES SLIDING GATE
ZWEI FLÜGEL SCHIEBETOR



DE06



Portail Battant / Swing Gate / Doppeltor
DE06

Portillon / Pedestrian Gate / Einzeltor
DE06

Portail Couissant / Sliding Gate / Schiebetor
DE06

Clôture / Fence / Zaun
AG18



DE14

CARACTÉRISTIQUES
Features / Eigenschaften



**TRAVERSE RENFORCÉE
POUR MOTORISATION**

REINFORCED PROFIL FOR MOTORIZATION
VERSTÄRKTE PROFIL FÜR MOTOREINBAU



LAME 200mm
BLADE 200mm
LAMELLE 200mm



**PANNEAU
DÉCORATIF**
DECORATIVE
PANEL
DEKORATIV
PLATTE



VITRAGE
FROSTED GLASS
MILCHGLAS



ALUNOX

POSSIBILITÉS
Options / Optionen



SUR MESURE
BESPOKE
MAßANFERTIGUNG



COULISSANT 2 VANTAUX
2 LEAVES SLIDING GATE
ZWEI FLÜGEL SCHIEBETOR



Portail Battant / Swing Gate / Doppeltor
DE14

Portillon / Pedestrian Gate / Einzeltor
DE14

Portail Couissant / Sliding Gate / Schiebetor
DE14

Clôture / Fence / Zaun
AG18

Portail Battant et Couissant
Swinging and Sliding Gates / Doppeltor und Schiebetor

DIMENSIONS
Dimensions / Maße

Largeur / Width / Breite (Minimum 2500mm / Maximum 5000mm)
Hauteur / Height / Höhe (Minimum 1400mm / Maximum 2200mm)

Portillon
Pedestrian Gate / Einzeltor

Largeur / Width / Breite (Minimum 800mm / Maximum 1400mm)
Hauteur / Height / Höhe (Minimum 1400mm / Maximum 2200mm)

DE19



CARACTÉRISTIQUES
Features / Eigenschaften



**TRAVERSE RENFORCÉE
POUR MOTORISATION**
REINFORCED TRAVERSE FOR MOTORIZATION
VERSTÄRKTE PROFIL FÜR MOTOREINBAU



LAME 200mm
BLADE 200mm
LAMELLE 200mm



**PANNEAU
DÉCORATIF**
DECORATIVE
PANEL
DEKORATIV
PLATTE



VITRAGE
FROSTED GLASS
MILCHGLAS



ALUNOX

POSSIBILITÉS
Options / Optionen



SUR MESURE
BESPOKE
MAßANFERTIGUNG



COULISSANT 2 VANTAUX
2 LEAVES SLIDING GATE
ZWEI FLÜGEL SCHIEBETOR

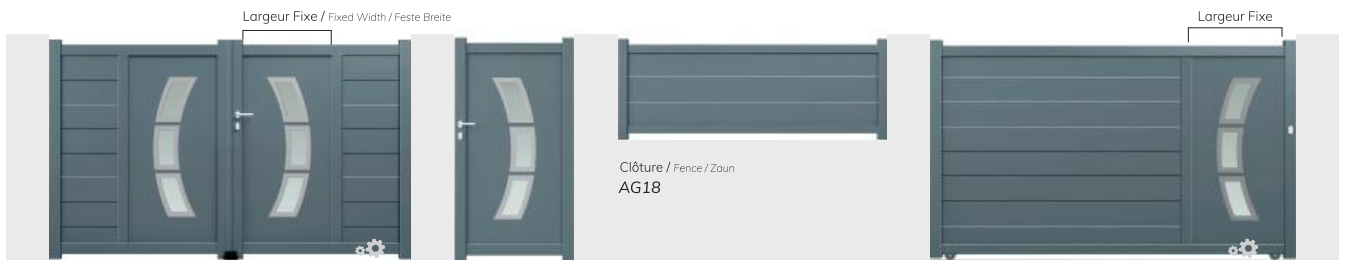

Portail Battant / Swing Gate / Doppeltor
DE19

Portillon / Pedestrian Gate / Einzeltor
DE19

Portail Coulissant / Sliding Gate / Schiebetor
DE19

CARACTÉRISTIQUES
Features / Eigenschaften



**TRAVERSE RENFORCÉE
POUR MOTORISATION**
REINFORCED TRAVERSE FOR MOTORIZATION
VERSTÄRKTE PROFIL FÜR MOTOREINBAU



LAME 200mm
BLADE 200mm
LAMELLE 200mm



**PANNEAU
DÉCORATIF**
DECORATIVE
PANEL
DEKORATIV
PLATTE



VITRAGE
FROSTED GLASS
MILCHGLAS



ALUNOX

POSSIBILITÉS
Options / Optionen



SUR MESURE
BESPOKE
MAßANFERTIGUNG



COULISSANT 2 VANTAUX
2 LEAVES SLIDING GATE
ZWEI FLÜGEL SCHIEBETOR



DE26



Portail Battant / Swing Gate / Doppeltor
DE26

Portillon / Pedestrian Gate / Einzeltor
DE26

Portail Coulissant / Sliding Gate / Schiebetor
DE26

Portail Battant et Coulissant
Swinging and Sliding Gates / Doppeltor und Schiebetor

DIMENSIONS
Dimensions / Maße

Largeur / Width / Breite (Minimum 2500mm / Maximum 5000mm)
Hauteur / Height / Höhe (Minimum 1400mm / Maximum 2200mm)

Portillon
Pedestrian Gate / Einzeltor

Largeur / Width / Breite (Minimum 800mm / Maximum 1400mm)
Hauteur / Height / Höhe (Minimum 1400mm / Maximum 2200mm)

CARACTÉRISTIQUES
Features / Eigenschaften



**TRAVERSE RENFORCÉE
POUR MOTORISATION**
REINFORCED TRAVERSE FOR MOTORIZATION
VERSTÄRKTES PROFIL FÜR MOTOREINBAU



LAME 200mm
BLADE 200mm
LAMELLE 200mm



**PANNEAU
DÉCORATIF**
DECORATIVE
PANEL
DEKORATIV
PLATTE



VITRAGE
FROSTED GLASS
MILCHGLAS



ALUNOX

POSSIBILITÉS
Options / Optionen



SUR MESURE
BESPOKE
MAßANFERTIGUNG



COULISSANT 2 VANTAUX
2 LEAVES SLIDING GATE
ZWEI FLÜGEL SCHIEBETOR



DE24



Portail Battant / Swing Gate / Doppeltor
DE24

Portillon / Pedestrian Gate / Einzeltor
DE24

Portail Coulissant / Sliding Gate / Schiebetor
DE24



DE21

CARACTÉRISTIQUES
Features / Eigenschaften



**TRAVERSE RENFORCÉE
POUR MOTORISATION**
REINFORCED TRAVERSE FOR MOTORIZATION
VERSTÄRKTES PROFIL FÜR MOTOREINBAU



LAME 200mm
BLADE 200mm
LAMELLE 200mm



**PANNEAU
DÉCORATIF**
DECORATIVE
PANEL
DEKORATIV
PLATTE



VITRAGE
FROSTED GLASS
MILCHGLAS



ALUNOX

POSSIBILITÉS
Options / Optionen



SUR MESURE
BESPOKE
MAßANFERTIGUNG



COULISSANT 2 VANTAUX
2 LEAVES SLIDING GATE
ZWEI FLÜGEL SCHIEBETOR



Portail Battant / Swing Gate / Doppeltor
DE21

Portillon / Pedestrian Gate / Einzeltor
DE21

Portail Coulissant / Sliding Gate / Schiebetor
DE21

Portail Battant et Coulissant
Swinging and Sliding Gates / Doppeltor und Schiebetor

DIMENSIONS
Dimensions / Maße

Largeur / Width / Breite (Minimum 2500mm / Maximum 5000mm)
Hauteur / Height / Höhe (Minimum 1400mm / Maximum 2200mm)

Portillon
Pedestrian Gate / Einzeltor

Largeur / Width / Breite (Minimum 800mm / Maximum 1400mm)
Hauteur / Height / Höhe (Minimum 1400mm / Maximum 2200mm)

DE02



CARACTÉRISTIQUES
Features / Eigenschaften



**TRAVERSE RENFORCÉE
POUR MOTORISATION**
REINFORCED TRAVERSE FOR MOTORIZATION
VERSTÄRKTE PROFIL FÜR MOTOREINBAU



LAME 200mm
BLADE 200mm
LAMELLE 200mm



**PANNEAU
DÉCORATIF**
DECORATIVE
PANEL
DEKORATIV
PLATTE



VITRAGE
FROSTED GLASS
MILCHGLAS



ALUNOX

POSSIBILITÉS
Options / Optionen



SUR MESURE
BESPOKE
MAßANFERTIGUNG



COULISSANT 2 VANTAUX
2 LEAVES SLIDING GATE
ZWEI FLÜGEL SCHIEBETOR

Largeur Fixe / Fixed Width / Feste Breite



Portail Battant / Swing Gate / Doppeltor
DE02

Portillon / Pedestrian Gate / Einzeltor
DE02

Portail Couissant / Sliding Gate / Schiebetor
DE02

Clôture / Fence / Zaun
AG18

DESIGN

CARACTÉRISTIQUES
Features / Eigenschaften



**TRAVERSE RENFORCÉE
POUR MOTORISATION**
REINFORCED TRAVERSE FOR MOTORIZATION
VERSTÄRKTE PROFIL FÜR MOTOREINBAU



LAME 200mm
BLADE 200mm
LAMELLE 200mm



**PANNEAU
DÉCORATIF**
DECORATIVE
PANEL
DEKORATIV
PLATTE



VITRAGE
FROSTED GLASS
MILCHGLAS

POSSIBILITÉS
Options / Optionen



SUR MESURE
BESPOKE
MAßANFERTIGUNG



COULISSANT 2 VANTAUX
2 LEAVES SLIDING GATE
ZWEI FLÜGEL SCHIEBETOR



DE22

Largeur Fixe / Fixed Width / Feste Breite



Portail Battant / Swing Gate / Doppeltor
DE22

Portillon / Pedestrian Gate / Einzeltor
DE22

Portail Couissant / Sliding Gate / Schiebetor
DE22

Clôture / Fence / Zaun
AG18

Portail Battant et Couissant
Swinging and Sliding Gates / Doppeltor und Schiebetor

DIMENSIONS
Dimensions / Maße
Largeur / Width / Breite (Minimum 2500mm / Maximum 5000mm)
Hauteur / Height / Höhe (Minimum 1400mm / Maximum 2200mm)

Portillon
Pedestrian Gate / Einzeltor

Largeur / Width / Breite (Minimum 800mm / Maximum 1400mm)
Hauteur / Height / Höhe (Minimum 1400mm / Maximum 2200mm)

CARACTÉRISTIQUES
Features / Eigenschaften



**TRAVERSE RENFORCÉE
POUR MOTORISATION**
REINFORCED TRAVERSE FOR MOTORIZATION
VERSTÄRKTES PROFIL FÜR MOTOREINBAU



LAME 200mm
BLADE 200mm
LAMELLE 200mm



**PANNEAU
DÉCORATIF**
DECORATIVE
PANEL
DEKORATIV
PLATTE



VITRAGE
FROSTED GLASS
MILCHGLAS



ALUNOX

POSSIBILITÉS
Options / Optionen



SUR MESURE
BESPOKE
MAßANFERTIGUNG



COULISSANT 2 VANTAUX
2 LEAVES SLIDING GATE
ZWEI FLÜGEL SCHIEBETOR



DE17



Portail Battant / Swing Gate / Doppeltor
DE17

Portillon / Pedestrian Gate / Einzeltor
DE17

Portail Coulissant / Sliding Gate / Schiebetor
DE17

DE23



CARACTÉRISTIQUES
Features / Eigenschaften



**TRAVERSE RENFORCÉE
POUR MOTORISATION**
REINFORCED TRAVERSE FOR MOTORIZATION
VERSTÄRKTES PROFIL FÜR MOTOREINBAU



LAME 200mm
BLADE 200mm
LAMELLE 200mm



**PANNEAU
DÉCORATIF**
DECORATIVE
PANEL
DEKORATIV
PLATTE



VITRAGE
FROSTED GLASS
MILCHGLAS

POSSIBILITÉS
Options / Optionen



SUR MESURE
BESPOKE
MAßANFERTIGUNG



COULISSANT 2 VANTAUX
2 LEAVES SLIDING GATE
ZWEI FLÜGEL SCHIEBETOR



Portail Battant / Swing Gate / Doppeltor
DE23

Portillon / Pedestrian Gate / Einzeltor
DE23

Portail Coulissant / Sliding Gate / Schiebetor
DE23

Portail Battant et Coulissant
Swinging and Sliding Gates / Doppeltor und Schiebetor

DIMENSIONS
Dimensions / Maße

Largeur / Width / Breite (Minimum 2500mm / Maximum 5000mm)
Hauteur / Height / Höhe (Minimum 1400mm / Maximum 2200mm)

Portillon
Pedestrian Gate / Einzeltor

Largeur / Width / Breite (Minimum 800mm / Maximum 1400mm)
Hauteur / Height / Höhe (Minimum 1400mm / Maximum 2200mm)

DE04



CARACTÉRISTIQUES
Features / Eigenschaften



**TRAVERSE RENFORCÉE
POUR MOTORISATION**
REINFORCED TRAVERSE FOR MOTORIZATION
VERSTÄRKTE PROFIL FÜR MOTOREINBAU



LAME 200mm
BLADE 200mm
LAMELLE 200mm



**PANNEAU
DÉCORATIF**
DECORATIVE
PANEL
DEKORATIV
PLATTE



VITRAGE
FROSTED GLASS
MILCHGLAS

POSSIBILITÉS
Options / Optionen



SUR MESURE
BESPOKE
MAßANFERTIGUNG



COULISSANT 2 VANTAUX
2 LEAVES SLIDING GATE
ZWEI FLÜGEL SCHIEBETOR



Portail Battant / Swing Gate / Doppeltor
DE04

Portillon / Pedestrian Gate / Einzeltor
DE04

Portail Coulissant / Sliding Gate / Schiebetor
DE04

DESIGN

CARACTÉRISTIQUES
Features / Eigenschaften



**TRAVERSE RENFORCÉE
POUR MOTORISATION**
REINFORCED TRAVERSE FOR MOTORIZATION
VERSTÄRKTE PROFIL FÜR MOTOREINBAU



LAME 200mm
BLADE 200mm
LAMELLE 200mm



**PANNEAU
DÉCORATIF**
DECORATIVE
PANEL
DEKORATIV
PLATTE



VITRAGE
FROSTED GLASS
MILCHGLAS



ALUNOX

POSSIBILITÉS
Options / Optionen



SUR MESURE
BESPOKE
MAßANFERTIGUNG



COULISSANT 2 VANTAUX
2 LEAVES SLIDING GATE
ZWEI FLÜGEL SCHIEBETOR

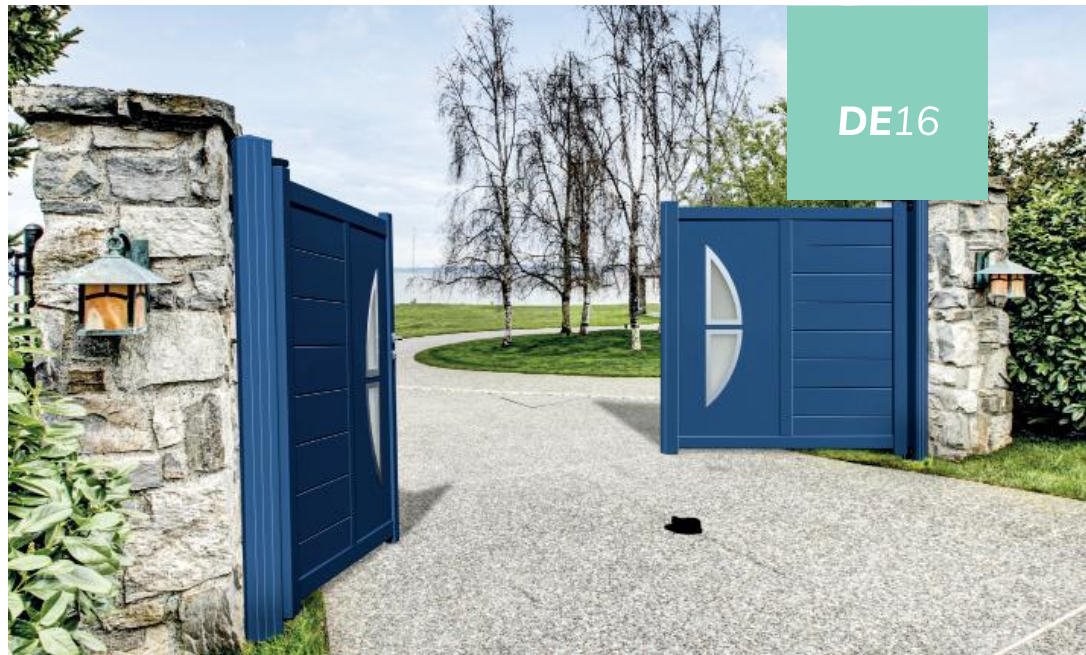

DE16



Portail Battant / Swing Gate / Doppeltor
DE16

Portillon / Pedestrian Gate / Einzeltor
DE16

Portail Coulissant / Sliding Gate / Schiebetor
DE16

Portail Battant et Coulissant
Swinging and Sliding Gates / Doppeltor und Schiebetor

DIMENSIONS
Dimensions / Maße

Largeur / Width / Breite (Minimum 2500mm / Maximum 5000mm)
Hauteur / Height / Höhe (Minimum 1400mm / Maximum 2200mm)

Portillon
Pedestrian Gate / Einzeltor

Largeur / Width / Breite (Minimum 800mm / Maximum 1400mm)
Hauteur / Height / Höhe (Minimum 1400mm / Maximum 2200mm)

CARACTÉRISTIQUES
Features / Eigenschaften



**TRAVERSE RENFORCÉE
POUR MOTORISATION**
REINFORCED TRAVERSE FOR MOTORIZATION
VERSTÄRKTE PROFIL FÜR MOTOREINBAU



LAME 200mm
BLADE 200mm
LAMELLE 200mm



**PANNEAU
DÉCORATIF**
DECORATIVE
PANEL
DEKORATIV
PLATTE



ALUNOX

POSSIBILITÉS
Options / Optionen



SUR MESURE
BESPOKE
MAßANFERTIGUNG



COULISSANT 2 VANTAUX
2 LEAVES SLIDING GATE
ZWEI FLÜGEL SCHIEBETOR



DE12



Portail Battant / Swing Gate / Doppeltor
DE12

Portillon / Pedestrian Gate / Einzeltor
DE12

Portail Coulissant / Sliding Gate / Schiebetor
DE12

Clôture / Fence / Zaun
AG18



DE25

CARACTÉRISTIQUES
Features / Eigenschaften



**TRAVERSE RENFORCÉE
POUR MOTORISATION**
REINFORCED TRAVERSE FOR MOTORIZATION
VERSTÄRKTE PROFIL FÜR MOTOREINBAU



LAME 200mm
BLADE 200mm
LAMELLE 200mm



**PANNEAU
DÉCORATIF**
DECORATIVE
PANEL
DEKORATIV
PLATTE



VITRAGE
FROSTED GLASS
MILCHGLAS



ALUNOX

POSSIBILITÉS
Options / Optionen



SUR MESURE
BESPOKE
MAßANFERTIGUNG



COULISSANT 2 VANTAUX
2 LEAVES SLIDING GATE
ZWEI FLÜGEL SCHIEBETOR



Portail Battant / Swing Gate / Doppeltor
DE25

Portillon / Pedestrian Gate / Einzeltor
DE25

Portail Coulissant / Sliding Gate / Schiebetor
DE25

Clôture / Fence / Zaun
AG18

Portail Battant et Coulissant
Swinging and Sliding Gates / Doppeltor und Schiebetor

DIMENSIONS
Dimensions / Maße

Largeur / Width / Breite (Minimum 2500mm / Maximum 5000mm)
Hauteur / Height / Höhe (Minimum 1400mm / Maximum 2200mm)

Portillon
Pedestrian Gate / Einzeltor

Largeur / Width / Breite (Minimum 800mm / Maximum 1400mm)
Hauteur / Height / Höhe (Minimum 1400mm / Maximum 2200mm)

DE13



CARACTÉRISTIQUES
Features / Eigenschaften

**TRaverse RENFORCÉE
POUR MOTORISATION**
REINFORCED TRAVERSE FOR MOTORIZATION
VERSTÄRKTE PROFIL FÜR MOTOREINBAU



**PANNEAU
DÉCORATIF**
DECORATIVE
PANEL
DEKORATIV
PLATTE



VITRAGE
FROSTED GLASS
MILCHGLAS



ALUNOX

POSSIBILITÉS
Options / Optionen



SUR MESURE
BESPOKE
MAßANFERTIGUNG



COULISSANT 2 VANTAUX
2 LEAVES SLIDING GATE
ZWEI FLÜGEL SCHIEBETOR



Portail Battant / Swing Gate / Doppeltor
DE13

Portillon / Pedestrian Gate / Einzeltor
DE13

Portail Couissant / Sliding Gate / Schiebetor
DE13

CARACTÉRISTIQUES
Features / Eigenschaften

**TRaverse RENFORCÉE
POUR MOTORISATION**
REINFORCED TRAVERSE FOR MOTORIZATION
VERSTÄRKTE PROFIL FÜR MOTOREINBAU



**PANNEAU
DÉCORATIF**
DECORATIVE
PANEL
DEKORATIV
PLATTE



ALUNOX

POSSIBILITÉS
Options / Optionen



SUR MESURE
BESPOKE
MAßANFERTIGUNG



COULISSANT 2 VANTAUX
2 LEAVES SLIDING GATE
ZWEI FLÜGEL SCHIEBETOR



DE01



Portail Battant / Swing Gate / Doppeltor
DE01

Portillon / Pedestrian Gate / Einzeltor
DE01

Portail Couissant / Sliding Gate / Schiebetor
DE01

Portail Battant et Couissant
Swinging and Sliding Gates / Doppeltor und Schiebetor

DIMENSIONS
Dimensions / Maße
Largeur / Width / Breite (Minimum 2500mm / Maximum 5000mm)
Hauteur / Height / Höhe (Minimum 1400mm / Maximum 2200mm)

Portillon
Pedestrian Gate / Einzeltor

Largeur / Width / Breite (Minimum 800mm / Maximum 1400mm)
Hauteur / Height / Höhe (Minimum 1400mm / Maximum 2200mm)

CARACTÉRISTIQUES
Features / Eigenschaften



**TRAVERSE RENFORCÉE
POUR MOTORISATION**

REINFORCED TRAVERSE FOR MOTORIZATION
VERSTÄRKTES PROFIL FÜR MOTOREINBAU



**PANNEAU
DÉCORATIF**
DECORATIVE
PANEL
DEKORATIV
PLATTE



VITRAGE
FROSTED GLASS
MILCHGLAS



ALUNOX

POSSIBILITÉS
Options / Optionen



SUR MESURE
BESPOKE
MAßANFERTIGUNG



COULISSANT 2 VANTAUX
2 LEAVES SLIDING GATE
ZWEI FLÜGEL SCHIEBETOR



DE27



Portail Battant / Swing Gate / Doppeltor
DE27

Portillon / Pedestrian Gate / Einzeltor
DE27

Portail Coulissant / Sliding Gate / Schiebetor
DE27

Clôture / Fence / Zaun
AG23



DE15

CARACTÉRISTIQUES
Features / Eigenschaften



**TRAVERSE RENFORCÉE
POUR MOTORISATION**

REINFORCED TRAVERSE FOR MOTORIZATION
VERSTÄRKTES PROFIL FÜR MOTOREINBAU



**PANNEAU
DÉCORATIF**
DECORATIVE
PANEL
DEKORATIV
PLATTE



VITRAGE
FROSTED GLASS
MILCHGLAS



ALUNOX

POSSIBILITÉS
Options / Optionen



SUR MESURE
BESPOKE
MAßANFERTIGUNG



COULISSANT 2 VANTAUX
2 LEAVES SLIDING GATE
ZWEI FLÜGEL SCHIEBETOR



Portail Battant / Swing Gate / Doppeltor
DE15

Portillon / Pedestrian Gate / Einzeltor
DE15

Portail Coulissant / Sliding Gate / Schiebetor
DE15

Clôture / Fence / Zaun
AG23

Portail Battant et Coulissant
Swinging and Sliding Gates / Doppeltor und Schiebetor

DIMENSIONS
Dimensions / Maße

Largeur / Width / Breite (Minimum 2500mm / Maximum 5000mm)
Hauteur / Height / Höhe (Minimum 1400mm / Maximum 2200mm)

Portillon
Pedestrian Gate / Einzeltor

Largeur / Width / Breite (Minimum 800mm / Maximum 1400mm)
Hauteur / Height / Höhe (Minimum 1400mm / Maximum 2200mm)

DESIGN





TRINÔME

Solution coordonnées: Portail, Porte d'entrée et Porte de Garage
Matching Solutions: Garden Gate, Front Door and Garage Gate







PLENUS

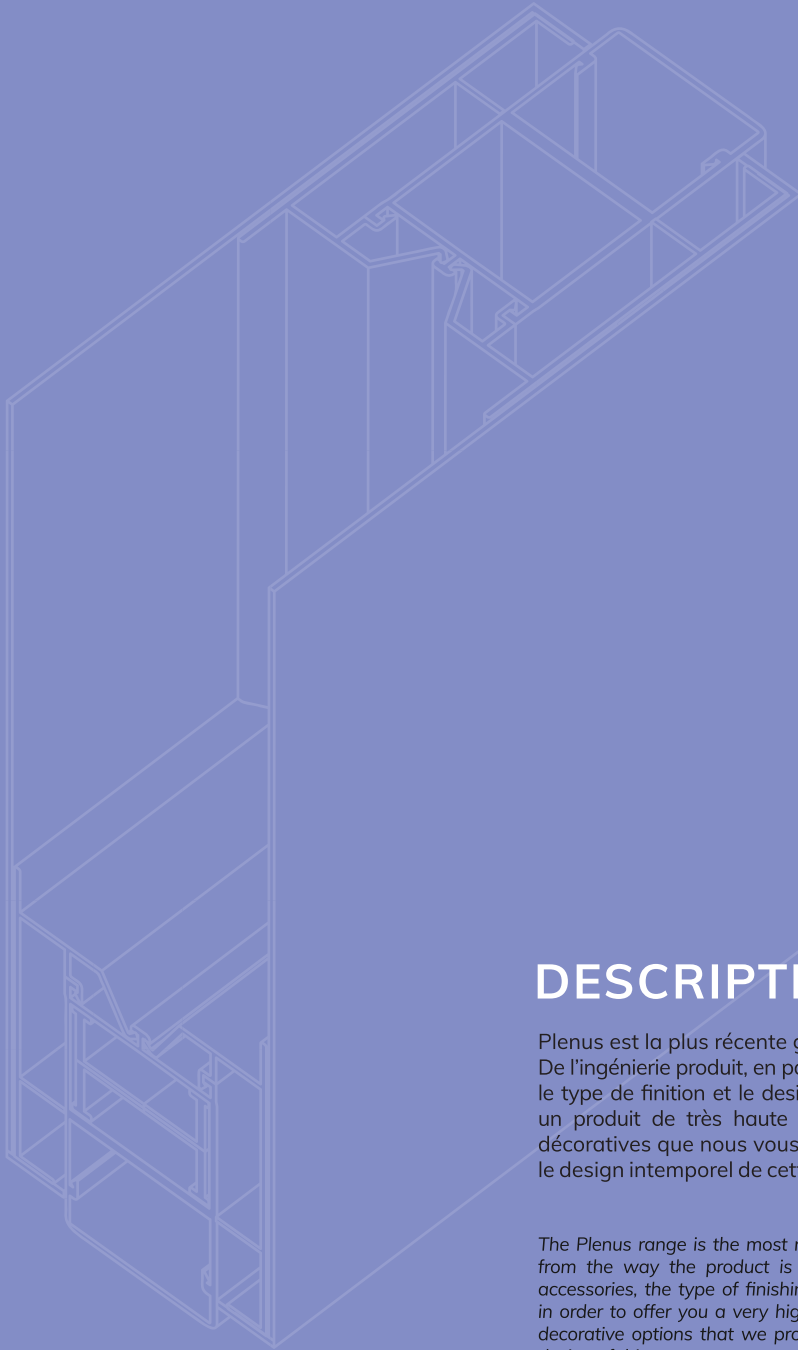

DESCRIPTION

Plenus est la plus récente gamme des portails Gardengate. De l'ingénierie produit, en passant par le choix des accessoires, le type de finition et le design, tout est pensé pour vous offrir un produit de très haute qualité. Les nombreuses options décoratives que nous vous proposons, permettent d'adapter le design intemporel de cette gamme de produits à vos goûts.

The Plenus range is the most recente offer from Gardengate. Starting from the way the product is engineered, passing by the choice of accessories, the type of finishing and design, everything is developed in order to offer you a very high quality product. The large number of decorative options that we propose allows you to adapt the timeless design of this range to your specific tastes.

PORTAILS GATES / TORE

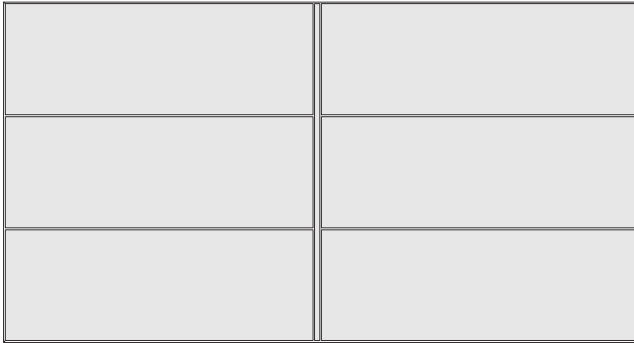

PN01
p. 124

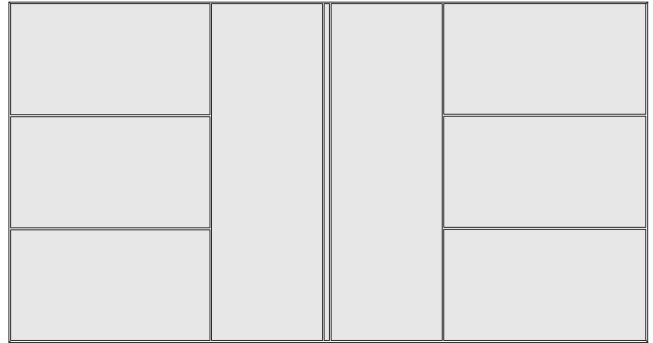

PN02
p. 126

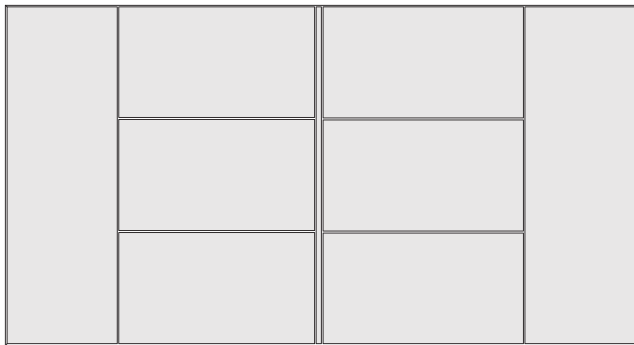

PN03
p. 128

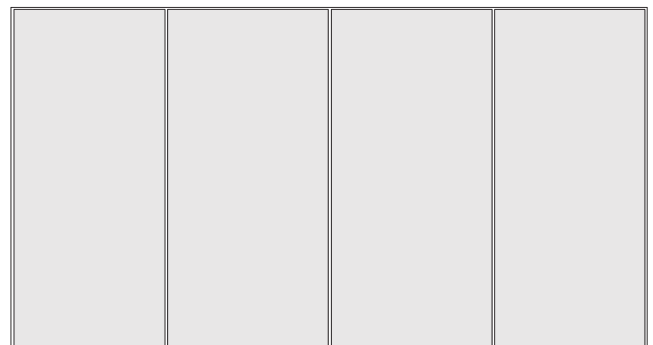

PN04
p. 130

PN01

PLENUS



CARACTÉRISTIQUES
Features / Eigenschaften



**TRAVERSE RENFORCÉE
POUR MOTORISATION**
REINFORCED TRAVERSE FOR MOTORIZATION
VERSTÄRKTES PROFIL FÜR MOTOREINBAU



TÔLE
ALUMINUM SHEET
ALUMINIUMBLATT

POSSIBILITÉS
Options / Optionen



SUR MESURE
BESPOKE
MAßANFERTIGUNG



Portail Battant / Swing Gate / Doppeltor
PN01

Portillon / Pedestrian Gate
/ Einzeltor
PN01

Portail Coulissant / Sliding Gate / Schiebetor
PN01



**OPTION
TON BOIS**

OPTION WOOD FINISHING
OPTION HOLZDEKOR

Portail Battant et Coulissant
Swinging and Sliding Gates / Doppeltor und Schiebetor

DIMENSIONS
Dimensions / Maße

Largeur / Width / Breite (Minimum 2500mm / Maximum 4500mm)
Hauteur / Height / Höhe (Minimum 1200mm / Maximum 2000mm)

Portillon
Pedestrian Gate / Einzeltor

Largeur / Width / Breite (Minimum 800mm / Maximum 1200mm)
Hauteur / Height / Höhe (Minimum 1200mm / Maximum 2000mm)

DÉCORS

DESIGNS



Portail Battant / Swing Gate / Doppeltor	Portillon / Pedestrian Gate / Einzeltor	Portail Couissant / Sliding Gate / Schiebtor
PN01 - F1	PN01 - F1	PN01 - F1



Portail Battant / Swing Gate / Doppeltor	Portillon / Pedestrian Gate / Einzeltor	Portail Couissant / Sliding Gate / Schiebtor
PN01 - F2	PN01 - F2	PN01 - F2



Portail Battant / Swing Gate / Doppeltor	Portillon / Pedestrian Gate / Einzeltor	Portail Couissant / Sliding Gate / Schiebtor
PN01 - F3	PN01 - F3	PN01 - F3



Portail Battant / Swing Gate / Doppeltor	Portillon / Pedestrian Gate / Einzeltor	Portail Couissant / Sliding Gate / Schiebtor
PN01 - F4	PN01 - F4	PN01 - F4



Portail Battant / Swing Gate / Doppeltor	Portillon / Pedestrian Gate / Einzeltor	Portail Couissant / Sliding Gate / Schiebtor
PN01 - F5	PN01 - F5	PN01 - F5



Portail Battant / Swing Gate / Doppeltor	Portillon / Pedestrian Gate / Einzeltor	Portail Couissant / Sliding Gate / Schiebtor
PN01 - F6	PN01 - F6	PN01 - F6



Portail Battant / Swing Gate / Doppeltor	Portillon / Pedestrian Gate / Einzeltor	Portail Couissant / Sliding Gate / Schiebtor
PN01 - F7	PN01 - F7	PN01 - F7



Portail Battant / Swing Gate / Doppeltor	Portillon / Pedestrian Gate / Einzeltor	Portail Couissant / Sliding Gate / Schiebtor
PN01 - F8	PN01 - F8	PN01 - F8





CARACTÉRISTIQUES
Features / Eigenschaften



**TRAVERSE RENFORCÉE
POUR MOTORISATION**
REINFORCED TRAVERSE FOR MOTORIZATION
VERSTÄRKTE PROFIL FÜR MOTOREINBAU



TÔLE
ALUMINUM SHEET
ALUMINIUMBLATT

POSSIBILITÉS
Options / Optionen



SUR MESURE
BESPOKE
MAßANFERTIGUNG



Portail Battant / Swing Gate / Doppeltor
PN02

Portillon / Pedestrian Gate / Einzeltor
PN02

Portail Coulissant / Sliding Gate / Schiebetor
PN02



RAL 7016 STR

RAL 9006 STR

**DISPONIBLE EN
BI-COULEUR**

AVAILABLE IN BI-COLOUR
ZWEIFARBIG VERFÜGBAR

Autres couleurs disponibles / Other colours
available / Andere Farben erhältlich

Portail Battant et Coulissant
Swinging and Sliding Gates / Doppeltor und Schiebetor

DIMENSIONS
Dimensions / Maße

Largeur / Width / Breite (Minimum 2500mm / Maximum 4500mm)
Hauteur / Height / Höhe (Minimum 1200mm / Maximum 2000mm)

Portillon
Pedestrian Gate / Einzeltor

Largeur / Width / Breite (Minimum 800mm / Maximum 1200mm)
Hauteur / Height / Höhe (Minimum 1200mm / Maximum 2000mm)

DÉCORS

DESIGNS



Portail Battant / Swing Gate / Doppeltor PN02 - F1	Portillon / Pedestrian Gate / Einzeltor PN02 - F1	Portail Couissant / Sliding Gate / Schiebetor PN02 - F1
--	---	---



Portail Battant / Swing Gate / Doppeltor PN02 - F2	Portillon / Pedestrian Gate / Einzeltor PN02 - F2	Portail Couissant / Sliding Gate / Schiebetor PN02 - F2
--	---	---



Portail Battant / Swing Gate / Doppeltor PN02 - F3	Portillon / Pedestrian Gate / Einzeltor PN02 - F3	Portail Couissant / Sliding Gate / Schiebetor PN02 - F3
--	---	---



Portail Battant / Swing Gate / Doppeltor PN02 - F4	Portillon / Pedestrian Gate / Einzeltor PN02 - F4	Portail Couissant / Sliding Gate / Schiebetor PN02 - F4
--	---	---



Portail Battant / Swing Gate / Doppeltor PN02 - F5	Portillon / Pedestrian Gate / Einzeltor PN02 - F5	Portail Couissant / Sliding Gate / Schiebetor PN02 - F5
--	---	---



Portail Battant / Swing Gate / Doppeltor PN02 - F6	Portillon / Pedestrian Gate / Einzeltor PN02 - F6	Portail Couissant / Sliding Gate / Schiebetor PN02 - F6
--	---	---



Portail Battant / Swing Gate / Doppeltor PN02 - F7	Portillon / Pedestrian Gate / Einzeltor PN02 - F7	Portail Couissant / Sliding Gate / Schiebetor PN02 - F7
--	---	---



Portail Battant / Swing Gate / Doppeltor PN02 - F8	Portillon / Pedestrian Gate / Einzeltor PN02 - F8	Portail Couissant / Sliding Gate / Schiebetor PN02 - F8
--	---	---



PLENUS

PN03



CARACTÉRISTIQUES
Features / Eigenschaften



**TRAVERSE RENFORCÉE
POUR MOTORISATION**
REINFORCED TRAVERSE FOR MOTORIZATION
VERSTÄRKTE PROFIL FÜR MOTOREINBAU



TÔLE
ALUMINUM SHEET
ALUMINIUMBLATT

POSSIBILITÉS
Options / Optionen



SUR MESURE
BESPOKE
MAßANFERTIGUNG

PLENUS



Portail Battant / Swing Gate / Doppeltor
PN03

Portillon / Pedestrian Gate / Einzeltor
PN03

Portail Coulissant / Sliding Gate / Schiebetor
PN03



RAL 7016 STR

RAL 9006 STR

**DISPONIBLE EN
BI-COULEUR**

AVAILABLE IN BI-COLOUR
ZWEIFARBIG VERFÜGBAR

Autres couleurs disponibles / Other colours
available / Andere Farben erhältlich

Portail Battant et Coulissant
Swinging and Sliding Gates / Doppeltor und Schiebetor

DIMENSIONS
Dimensions / Maße

Largeur / Width / Breite (Minimum 2500mm / Maximum 4500mm)
Hauteur / Height / Höhe (Minimum 1200mm / Maximum 2000mm)

Portillon
Pedestrian Gate / Einzeltor

Largeur / Width / Breite (Minimum 800mm / Maximum 1200mm)
Hauteur / Height / Höhe (Minimum 1200mm / Maximum 2000mm)



DÉCORS

DESIGNS



Portail Battant /
Swing Gate / Doppeltor
PN03 - F1

Portillon / Pedestrian
Gate / Einzeltor
PN03 - F1

Portail Couissant /
Sliding Gate / Schiebtor
PN03 - F1



Portail Battant /
Swing Gate / Doppeltor
PN03 - F2

Portillon / Pedestrian
Gate / Einzeltor
PN03 - F2

Portail Couissant /
Sliding Gate / Schiebtor
PN03 - F2



Portail Battant /
Swing Gate / Doppeltor
PN03 - F3

Portillon / Pedestrian
Gate / Einzeltor
PN03 - F3

Portail Couissant /
Sliding Gate / Schiebtor
PN03 - F3



Portail Battant /
Swing Gate / Doppeltor
PN03 - F4

Portillon / Pedestrian
Gate / Einzeltor
PN03 - F4

Portail Couissant /
Sliding Gate / Schiebtor
PN03 - F4



Portail Battant /
Swing Gate / Doppeltor
PN03 - F5

Portillon / Pedestrian
Gate / Einzeltor
PN03 - F5

Portail Couissant /
Sliding Gate / Schiebtor
PN03 - F5



Portail Battant /
Swing Gate / Doppeltor
PN03 - F6

Portillon / Pedestrian
Gate / Einzeltor
PN03 - F6

Portail Couissant /
Sliding Gate / Schiebtor
PN03 - F6



Portail Battant /
Swing Gate / Doppeltor
PN03 - F7

Portillon / Pedestrian
Gate / Einzeltor
PN03 - F7

Portail Couissant /
Sliding Gate / Schiebtor
PN03 - F7



Portail Battant /
Swing Gate / Doppeltor
PN03 - F8

Portillon / Pedestrian
Gate / Einzeltor
PN03 - F8

Portail Couissant /
Sliding Gate / Schiebtor
PN03 - F8





CARACTÉRISTIQUES
Features / Eigenschaften



**TRAVERSE RENFORCÉE
POUR MOTORISATION**
REINFORCED TRAVERSE FOR MOTORIZATION
VERSTÄRKTE PROFIL FÜR MOTOREINBAU



TÔLE
ALUMINUM SHEET
ALUMINIUMBLATT

POSSIBILITÉS
Options / Optionen



SUR MESURE
BESPOKE
MAßANFERTIGUNG

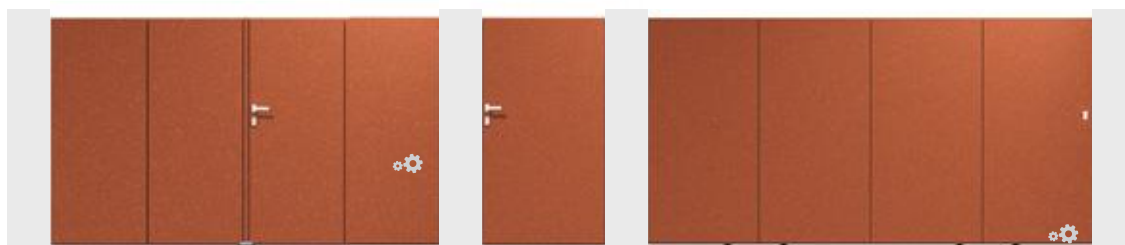

Portail Battant / Swing Gate / Doppeltor
PN04

Portillon / Pedestrian Gate
/ Einzeltor
PN04

Portail Coulissant / Sliding Gate / Schiebetor
PN04

Portail Battant et Coulissant
Swinging and Sliding Gates / Doppeltor und Schiebetor

DIMENSIONS
Dimensions / Maße

Largeur / Width / Breite (Minimum 2500mm / Maximum 4500mm)
Hauteur / Height / Höhe (Minimum 1200mm / Maximum 2000mm)

Portillon
Pedestrian Gate / Einzeltor

Largeur / Width / Breite (Minimum 800mm / Maximum 1200mm)
Hauteur / Height / Höhe (Minimum 1200mm / Maximum 2000mm)



DÉCORS

DESIGNS



Portail Battant /
Swing Gate / Doppeltor
PN04 - F1

Portillon / Pedestrian
Gate / Einzeltor
PN04 - F1

Portail Couissant /
Sliding Gate / Schiebetor
PN04 - F1



Portail Battant /
Swing Gate / Doppeltor
PN04 - F2

Portillon / Pedestrian
Gate / Einzeltor
PN04 - F2

Portail Couissant /
Sliding Gate / Schiebetor
PN04 - F2



Portail Battant /
Swing Gate / Doppeltor
PN04 - F3

Portillon / Pedestrian
Gate / Einzeltor
PN04 - F3

Portail Couissant /
Sliding Gate / Schiebetor
PN04 - F3



Portail Battant /
Swing Gate / Doppeltor
PN04 - F4

Portillon / Pedestrian
Gate / Einzeltor
PN04 - F4

Portail Couissant /
Sliding Gate / Schiebetor
PN04 - F4



Portail Battant /
Swing Gate / Doppeltor
PN04 - F5

Portillon / Pedestrian
Gate / Einzeltor
PN04 - F5

Portail Couissant /
Sliding Gate / Schiebetor
PN04 - F5



Portail Battant /
Swing Gate / Doppeltor
PN04 - F6

Portillon / Pedestrian
Gate / Einzeltor
PN04 - F6

Portail Couissant /
Sliding Gate / Schiebetor
PN04 - F6



Portail Battant /
Swing Gate / Doppeltor
PN04 - F7

Portillon / Pedestrian
Gate / Einzeltor
PN04 - F7

Portail Couissant /
Sliding Gate / Schiebetor
PN04 - F7



Portail Battant /
Swing Gate / Doppeltor
PN04 - F8

Portillon / Pedestrian
Gate / Einzeltor
PN04 - F8

Portail Couissant /
Sliding Gate / Schiebetor
PN04 - F8



PORTAIL BATTANT

TYPE D'OUVERTURE

SWING GATE OPENING TYPE

ENTRE PILIERS 90° / Between Pillars 90°



Vue en plan / Top view

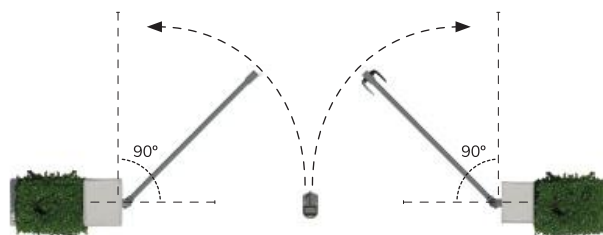

EN APPLIQUE / Face Mounting

Vue Intérieure / Inside view



Vue en plan / Top view

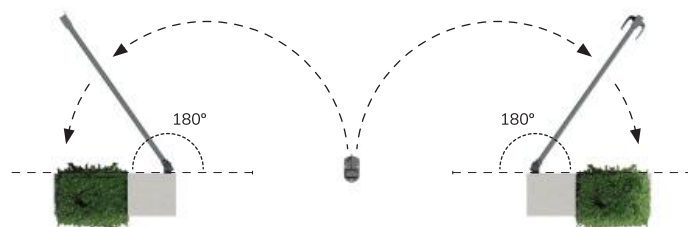

PENTE / Sloping

Vue Intérieure / Inside view



Ouverture en pente / Sloping Opening

Ouverture de portail en pente pour terrain incliné / Opening of the gate for sloping ground



ACCESSOIRES

ACCESSORIES

Battant

Swing Gate / Doppeltor

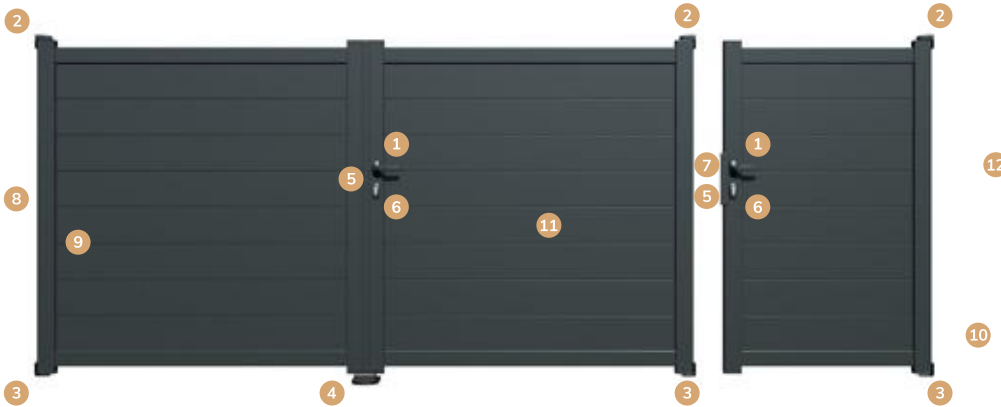

1 POIGNÉE Handle / Türgriff



GAMME PLENUS

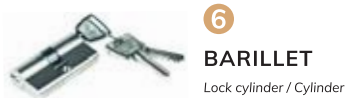

PROFIL BATTÉE
Slam plate for pedestrian gate / Anschlagleiste
DIMENSIONS
Longeur / Length (265mm)
Largeur / Width (55mm)
Hauteur / Height (39mm)

Options



2 · 3
GOND POUR PENTE
Uphill hinge / Scharnier für Neigung



12
DIGICODE



2 · 3
GOND MULTIREGLABLE AVEC CAPOT À LA COULEUR
Multi adjustable hinge with cover to match gate colour / Mehrfach verstellbares Scharnier mit Abdeckung passend zur Torfarbe



3
CRAPAUDINE
Bolt down hinge / Bodenscharnier



1 · 2
CAPOT ET POIGNÉE À LA COULEUR
Hinge cover and handle to match gate colour / Scharnierabdeckung und Griff in Torfarbe



2 · 3
GOND APPLIQUÉ À OUVERTURE 180°
Face mounting wrap hinge 180° / Scharnier mit Öffnung bis 180°



3
GOND À SCELLER
Concrete-in hinge / Bodenscharnier



5
SERRURE ÉLECTRIQUE
Electric Lock / Elektrisches Schloss



10
ARRÊT À SCELLER
Latching open stop / Torfeststeller für Torflügel



8
KIT OCCULTATION
Hinge gap cover / Sichtschutzleiste mit Bürstendichtung



7
PROFIL BATTÉE TOUTE HAUTEUR
Full height slam plate with keep / Anschlagleiste in Torhöhe



11
ROSACE ET POINTE DORÉE
Golden finials and rosette / Goldene Endstücke und Aluminiumprägung



7
GÂCHE ÉLECTRIQUE + PROFIL BATTÉE TOUTE HAUTEUR
Full height slam plate with electric rim release / Elektrisches Torschloß + Anschlagleiste in Torhöhe



9
BARRE CONTREVENTEMENT
Reinforcement bar for windy conditions / Torbefestigung für die Wand

PORTAIL COULISSANT

TYPE D'OUVERTURE

SLIDING GATE OPENING TYPE

COULISSANT DROIT / Straight Format

Vue Extérieure / Outside view

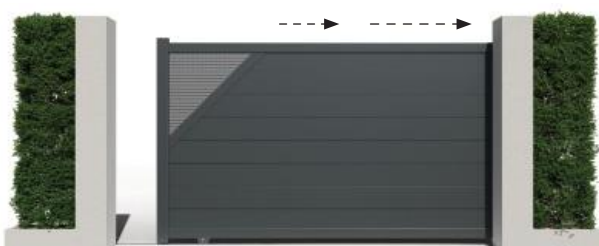

Vue Intérieure / Inside view



COULISSANT AVEC FORME / With shape

Vue Extérieure / Outside view

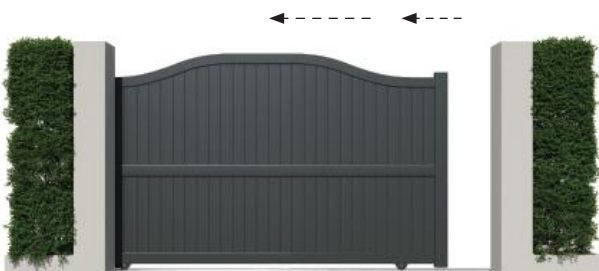

Vue Intérieure / Inside view

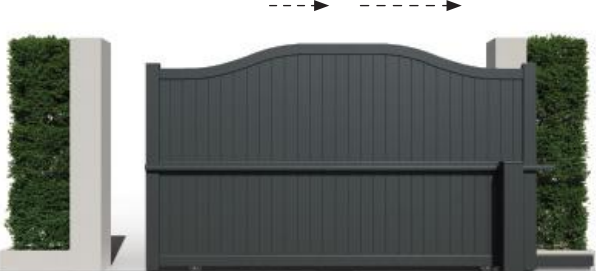

TYPES DE PORTAILS COULISSANT

Types of Sliding Gates

Coulissant 1 Vantail / 1 Leaf Sliding Gate

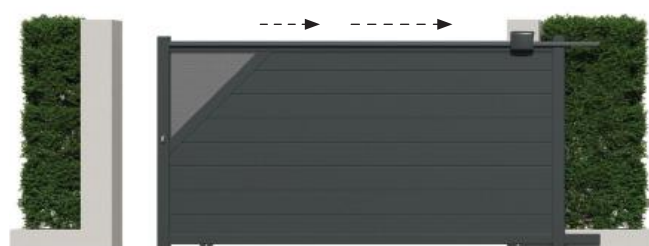

Coulissant Imitation Battant: 2 Vantaux /
Swing Gate Imitation: 2 Leaves Sliding Gate

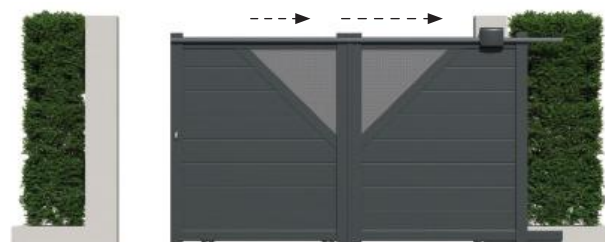

Coulissant Double Ouverture* / Two way Opening

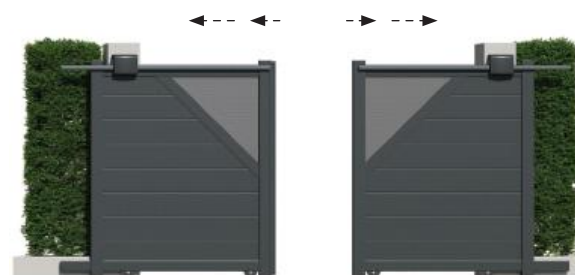

* Toujours avec la même esthétique que le portail battant /
The same look as a swing gate

ACCESSOIRES

ACCESSORIES

Coulissant Sliding Gate / Schiebetor



1
PLATINE DE GUIDAGE
Top guide support /
Führungplatte



2
GÂCHE DE RÉCEPTION
Close catch / Schießblech



3
SERRURE
Lock / Schloss



7
GALET ENCASTRÉ
Wheel / Laufrollen



8
BUTÉE
Open stop /
Torendanschlag



5
SUPPORT + RAIL DE GUIDAGE SUPÉRIEUR + PROFIL DE CLIPSAGE
Top guide rail with support and cover /
Halterung + Führungsschiene



6
RAIL DE GUIDAGE INFÉRIEUR
Bottom guide rail / Führungsschiene



4
BARILLET
Lock cylinder /
Cylinder

Options



9
KIT OCCULTATION
Brush strip kit for sliding gate /
Sichtschutzleiste mit Bürstendichtung



11
CRÉMAILLÈRE
Rack / Zahnstange



12
CACHE CRÉMAILLÈRE
Rack cover /
Zahnstangenabdeckung



15
ROSACE ET POINTE DORÉE
Golden finials and rosette / Goldene
Endstücke und Aluminiumprägung



4
POIGNÉE
Handle / Türgriff



4
POIGNÉE À LA COULEUR
Handle to match gate colour /
Griff-zu-Gate-Farbe



10
KIT POTEAU DE RÉCEPTION FIN DE COURSE (ouverture)
Open stop kit (post + catch) /
Endanschlagpfosten für Schiebetor



13
PROFIL RÉCEPTION TOUTE HAUTEUR (face ajustable)
Full height adjustable slam plate /
Einstellbare empfangsprofil in
vollständiger höhe



13
PROFIL RÉCEPTION TOUTE HAUTEUR (face)
Full height slam plate /
Empfangsprofil in vollständiger höhe



13
PROFIL RÉCEPTION TOUTE HAUTEUR (en applique)
Full height slam plate face mounting /
Empfangsprofil in vollständiger höhe
mit wandensatz



MOTEURS

GATE AUTOMATION

PORTAIL BATTANT Swing Gate

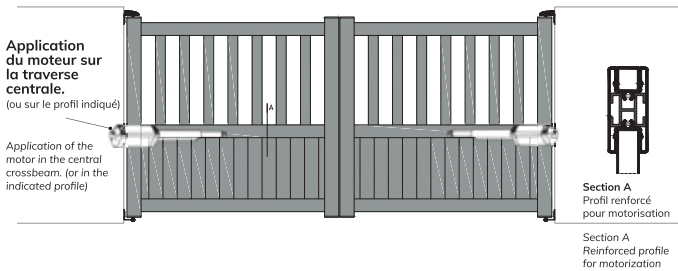

PORTAIL COULISSANT Sliding Gate

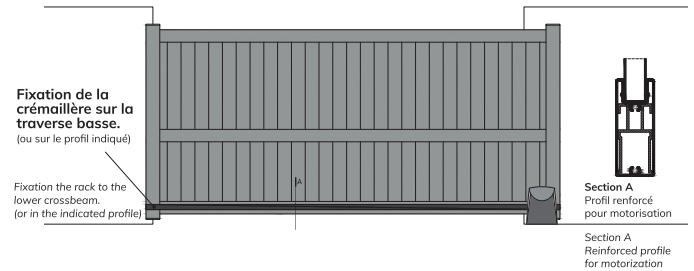

Veillez consulter la fiche technique du moteur afin de vérifier sa compatibilité pour installation chez le client final. /
Please consult the motor data sheet to check its compatibility for installation at the end customer.

somfy®

BATTANT * AXOVIA 3S io SWING GATE / DOPPELTOR

Modèle battant à bras articulé

Articulated arms swing gate opener / Drehtoröffner mit Gelenkarmen

Poids max — 200Kg

Max weight / Max. Gewicht

Angle max — 120°

Max angle / Max. Öffnungswinkel

Largeur maxi par vantail: 2M

Max length per leaf : 2000mm / Max. Flügelbreite : 2000mm

Composition du kit: / Kit composition

- 2 Motorisations Axovia 3S io;
2 Axovia 3S io motors / 2 Axovia 3S io Antriebe
- 2 Télécommandes Keygo io;
2 remote controls Keygo io / 2 Handsender Keygo io
- 1 Jeu de cellules photoélectriques;
1 pair of photocells / 1 Paar Lichtschranke
- 1 Feu orange MasterPro 24V antenne io;
1 flashing light / 1 Signalleuchte
- 1 Batterie de secours;
1 back-up battery / 1 Notstrombatterie
- Emballage blanc.
Neutral packaging / Neutrale Verpackung



BATTANT * IXENGO L 3S io SWING GATE / DOPPELTOR

Modèle battant à verin

Dual swing gate opener / Zweiflügeliger Toröffner

Poids max — 400Kg

Max weight / Max. Gewicht

Angle max — 145°

Max angle / Max. Öffnungswinkel

Largeur maxi par vantail: 4M

Max length per leaf : 4000mm / Max. Flügelbreite : 4000mm

Composition du kit: / Kit composition

- 2 Motorisations Ixengo L 3S io;
2 Ixengo L 3S io motors / 2 Ixengo L 3S io Antriebe
- 2 Télécommandes Keygo io;
2 remote controls Keygo io / 2 Handsender Keygo io
- 1 Jeu de cellules photoélectriques;
1 pair of photocells / 1 Paar Lichtschranke
- 1 Feu orange MasterPro 24V antenne io;
1 flashing light / 1 Signalleuchte
- 2 pattes piliers ajustables;
2 adjustable post supports / 2 verstellbare Pfostenträger
- 1 Batterie de secours;
1 back-up battery / 1 Notstrombatterie
- Emballage.
Neutral packaging / Neutrale Verpackung



COULISSANT * ELIXO SMART io SLIDING GATE / SCHIEBETOR

Modèle coulissant

Sliding gate opener / Schiebetoröffner

Poids max — 300Kg

Max weight / Max. Gewicht

Vitesse — 15cm/s

Speed / Geschwindigkeit

Largeur maxi par vantail: 6M

Max length per leaf : 6000mm / Max. Flügelbreite : 6000mm

Composition du kit: / Kit composition

- 1 Motorisation Elixo Smart io;
1 Elixo Smart io motor / 1 Elixo Smart io Antriebe
- 2 Télécommandes Keygo io;
2 remote controls Keygo io / 2 Handsender Keygo io
- 1 Jeu de cellules photoélectriques;
1 pair of photocells / 1 Paar Lichtschranke
- 1 Feu orange MasterPro 24V antenne io;
1 flashing light / 1 Signalleuchte
- 1 Plaque de fond acier.
1 steel base plate / 1 Stahlbodenplatte



PORTAIL AVEC MOTEUR INTÉGRÉ

GATE WITH INTEGRATED MOTOR



SECTION ET
FORME SPÉCIFIQUE
POUR L'INTÉGRATION
DU MOTEUR
DESIGN ADAPTED
FOR MOTOR INTEGRATION

- **Invisible**

Motorisation intégrée dans les montants du portail
Motors integrated into the gate uprights

- **Performante** *Efficient*

Ouverture en 10 secondes et adaptée à l'utilisation intensive
Full opening in 10 seconds. Suitable for intensive usage

- **Résistante** *Durable*

Haute résistance face aux intempéries
Highly resistant to extreme weather

- **Pratique** *Practical*

Moteur déjà programmé et prêt à monter sur votre portail
Motor already programmed and ready to assemble on your gate

- **Sécurisante** *Secure*

Photocellules incluses permettant de détecter tout obstacle
Photocells included to detect any obstacle

- **Nouveau système d'arrêt**

New stoppage system

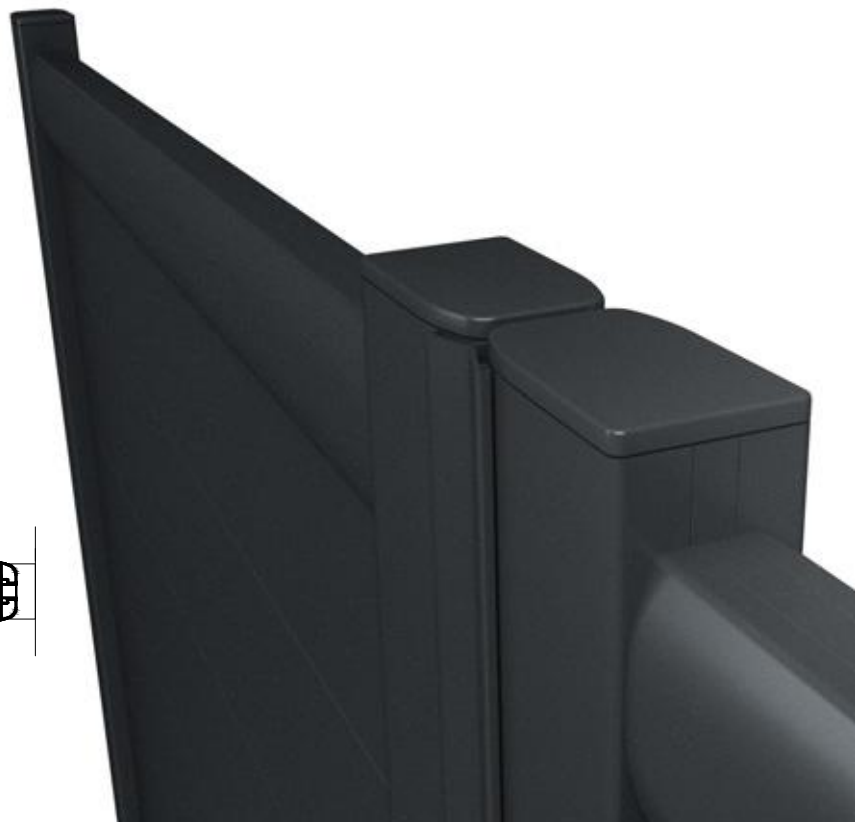
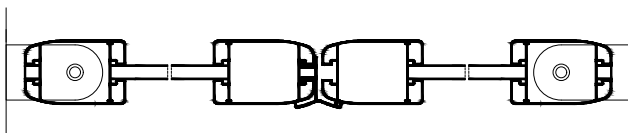



OPTION MOTEUR
 INTÉGRÉ - CONSULTEZ
 LA FAISABILITÉ SUR
 LES DERNIÈRES PAGES

INTEGRATED MOTOR OPTION
 - SEE THE FEASIBILITY ON
 THE LAST PAGES

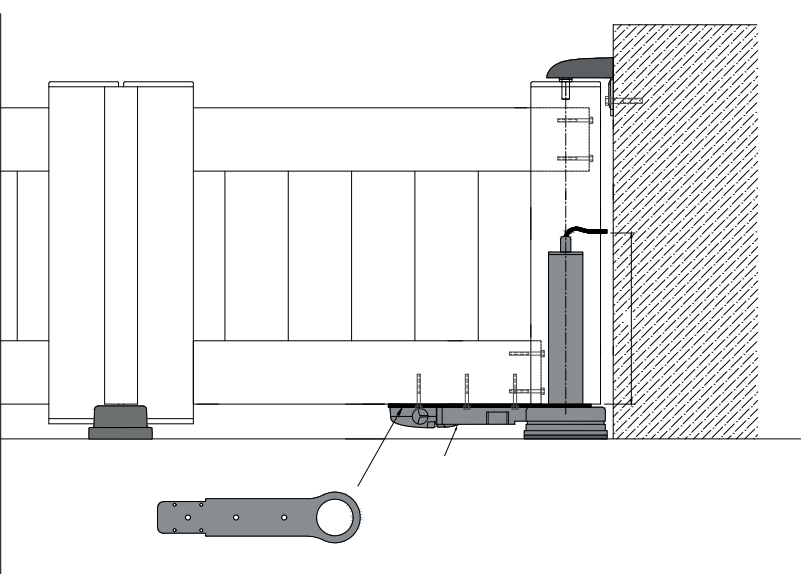

Intégration Moteur

Motor integration

Portillon Pedestrian gate

Les profils du portillon sont de la même section et design que ceux utilisés pour le portail avec la motorisation intégrée.

The profiles used in the pedestrian gate match the ones used in the motorized gate.



TOUJOURS AVEC
 CRAPAUDINE
 ALWAYS WITH BOLT
 DOWN HINGE



CHOISISSEZ
VOTRE MODÈLE
DE CLÔTURE

CHOOSE YOUR
FENCE MODEL

CLÔTURES

FENCING



AG11 (tube 70mm)

Largeur (Minimum 430mm / Maximum 2070mm)
Hauteur (Minimum 500mm / Maximum 1900mm)



AG12 (tube 70mm)

Largeur (Minimum 430mm / Maximum 2070mm)
Hauteur (Minimum 500mm / Maximum 1900mm)



AG13A | AG13B (tube 70mm)

Largeur (Minimum 1100mm / Maximum 2070mm)
AG13A  (500 < Hauteur < 1700mm)
AG13B  (700 < Hauteur < 1900mm)



AG14 (lame 100mm)

Largeur (Minimum 430mm / Maximum 2070mm)
Hauteur (Minimum 500mm / Maximum 1900mm)



AG15 (lame 100mm)

Largeur (Minimum 430mm / Maximum 2070mm)
Hauteur (Minimum 500mm / Maximum 1900mm)

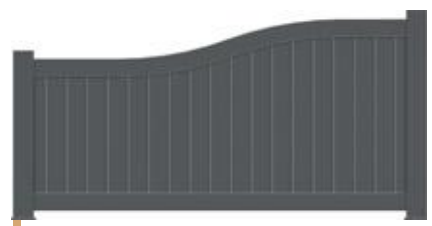

AG16A | AG16B (lame 100mm)

Largeur (Minimum 1100mm / Maximum 2070mm)
AG16A  (500 < Hauteur < 1700mm)
AG16B  (700 < Hauteur < 1900mm)



AG17 (lame 100mm)

Largeur (Minimum 430mm / Maximum 2070mm)
Hauteur (Minimum 500mm / Maximum 1900mm)



AG18 (lame 200mm)

Largeur (Minimum 430mm / Maximum 2070mm)
Hauteur (Minimum 500mm / Maximum 1900mm)



AG19 (lame 200mm)

Largeur (Minimum 430mm / Maximum 2070mm)
Hauteur (Minimum 500mm / Maximum 1900mm)



AG20 (traverse 60mm)

Largeur (Minimum 430mm / Maximum 2070mm)
Hauteur (Minimum 500mm / Maximum 1900mm)



AG21 (traverse 60mm)

Largeur (Minimum 430mm / Maximum 2070mm)
Hauteur (Minimum 500mm / Maximum 1900mm)



AG22 (traverse 60mm)

Largeur (Minimum 430mm / Maximum 2070mm)
Hauteur (Minimum 500mm / Maximum 1900mm)

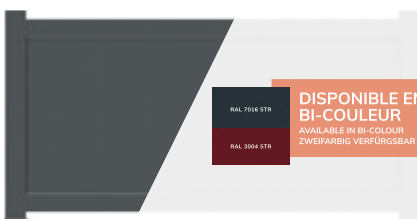

AG23 (tôle)

Largeur (Minimum 430mm / Maximum 2070mm)
Hauteur (Minimum 500mm / Maximum 1000mm)



AG24 (tube ventilée 64mm)

Largeur (Minimum 430mm / Maximum 2070mm)
Hauteur (Minimum 500mm / Maximum 1900mm)



AG25 (vitrage sablé)

Largeur (Minimum 430mm / Maximum 2070mm)
Hauteur (Minimum 500mm / Maximum 1000mm)

DISPONIBLE EN BI-COULEUR
AVAILABLE IN BI-COLOUR
ZWEIFARBIG VERFÜGBAR

RAL 7016 STR
RAL 3004 STR



OPTIONS TÔLE PERFORÉE
Perforated Aluminum Sheet Options



AG26 (tôle perforée)

Largeur (Minimum 430mm / Maximum 2070mm)
Hauteur (Minimum 500mm / Maximum 1000mm)



AG27 (panneau décoratif)

Largeur (Minimum 430mm / Maximum 2070mm)
Hauteur (Minimum 500mm / Maximum 1000mm)



AG28 (tôle aluminium effet bois)

Largeur (Minimum 430mm / Maximum 2070mm)
Hauteur (Minimum 500mm / Maximum 1000mm)



AG29 (lame 284mm)

Largeur (Minimum 430mm / Maximum 2070mm)
Hauteur (Minimum 500mm / Maximum 1900mm)

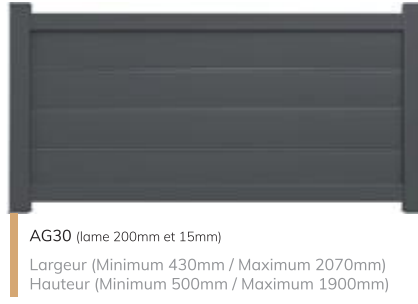

AG30 (lame 200mm et 15mm)

Largeur (Minimum 430mm / Maximum 2070mm)
Hauteur (Minimum 500mm / Maximum 1900mm)



AG31 (lame 200mm et profil décor 15mm)

Largeur (Minimum 430mm / Maximum 2070mm)
Hauteur (Minimum 500mm / Maximum 1900mm)

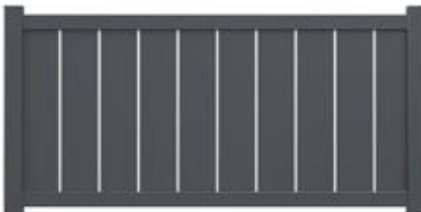

AG32 (lame 200mm et profil décor 15mm)

Largeur (Minimum 430mm / Maximum 2070mm)
Hauteur (Minimum 500mm / Maximum 1900mm)



AG33 (lame 200mm et profil décor 15mm)

Largeur (Minimum 430mm / Maximum 2070mm)
Hauteur (Minimum 500mm / Maximum 1900mm)



AG34 (lame 200mm et vitrage sablé)

Largeur (Minimum 630mm / Maximum 2070mm)
Hauteur (Minimum 800mm / Maximum 1900mm)



AG35 (lame 200mm et vitrage sablé)

Largeur (Minimum 770mm / Maximum 2070mm)
Hauteur (Minimum 650mm / Maximum 1900mm)



OPTIONS TÔLE PERFORÉE
Perforated Aluminum Sheet Options



AG36P (lame 200mm et tôle perforée)

Largeur (Minimum 630mm / Maximum 2070mm)
Hauteur (Minimum 800mm / Maximum 1900mm)



OPTIONS TÔLE PERFORÉE
Perforated Aluminum Sheet Options



AG37P (lame 200mm et tôle perforée)

Largeur (Minimum 770mm / Maximum 2070mm)
Hauteur (Minimum 650mm / Maximum 1900mm)

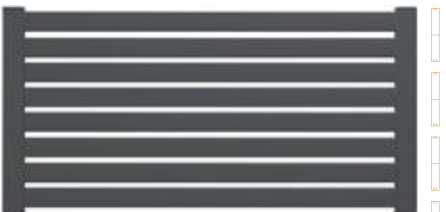

AG38 (tube 100mm ajouré)

Largeur (Minimum 430mm / Maximum 2070mm)
Hauteur (Minimum 500mm / Maximum 1900mm)

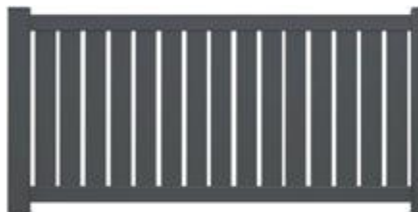

AG39 (tube 100mm ajouré)

Largeur (Minimum 430mm / Maximum 2070mm)
Hauteur (Minimum 500mm / Maximum 1900mm)



AG40 (tube ventilée 140mm)

Largeur (Minimum 430mm / Maximum 2070mm)
Hauteur (584mm | 716mm | 848mm | 980mm | 1112mm | 1244mm | 1376mm | 1508mm | 1640mm | 1772mm)



AG41 (lame épinée 100mm)

Largeur (Minimum 430mm / Maximum 2070mm)
Hauteur (265mm | 365mm | 465mm | 565mm | 665mm | 765mm | 865mm | 965mm | 1065mm | 1165mm | 1265mm | 1365mm | 1465mm | 1565mm | 1665mm | 1765mm | 1865mm)



AG42 (lame ondulée 100mm)

Largeur (Minimum 430mm / Maximum 2070mm)
Hauteur (256mm | 356mm | 456mm | 556mm | 656mm | 756mm | 856mm | 956mm | 1056mm | 1156mm | 1256mm | 1356mm | 1456mm | 1556mm | 1656mm | 1756mm)

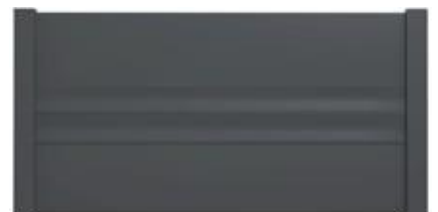

AG43 (lame 250mm et lame ondulée 100mm)

Largeur (Minimum 430mm / Maximum 2070mm)
Hauteur (714mm | 814mm | 914mm | 1164mm | 1364mm | 1414mm | 1564mm | 1614mm | 1814mm | 1864mm)



AG44 (tube 250mm ajouré)

Largeur (Minimum 430mm / Maximum 2070mm)
Hauteur (534mm | 804mm | 1074mm | 1344mm | 1614mm | 1884mm)



AG45 (lame 250mm et profil décor 15mm)

Largeur (Minimum 430mm / Maximum 2070mm)
Hauteur (529mm | 794mm | 1059mm | 1324mm | 1589mm | 1854mm)



AG46 (lame 250mm)

Largeur (Minimum 430mm / Maximum 2070mm)
Hauteur (514mm | 764mm | 1014mm | 1264mm | 1514mm | 1764mm)



AG47 (tube 250mm et tube 100mm ajouré)

Largeur (Minimum 430mm / Maximum 2070mm)
Hauteur (384mm | 654mm | 774mm | 1044mm | 1164mm | 1434mm | 1554mm | 1824mm)



AG48 (lame 200mm et profil décor 15mm)

Largeur (Minimum 910mm / Maximum 2070mm)
Hauteur (Minimum 500mm / Maximum 1900mm)



OPTION
POINTES DORÉES
Golden Finials Option



AG49 (tube 18mm et tôle)

Largeur (Minimum 430mm / Maximum 2070mm)
Hauteur (Minimum 500mm / Maximum 1900mm)



OPTION
POINTES DORÉES
Golden Tip Option



AG50 (tube 18mm)

Largeur (Minimum 430mm / Maximum 2070mm)
Hauteur (Minimum 500mm / Maximum 1900mm)

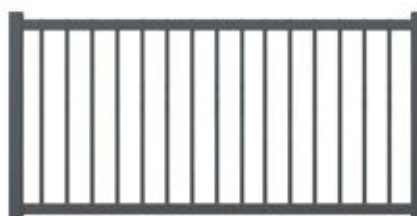

AG51 (tube 18mm)

Largeur (Minimum 430mm / Maximum 2070mm)
Hauteur (Minimum 500mm / Maximum 1900mm)



AG52 (tube persienne 160mm)

Largeur (Minimum 430mm / Maximum 2070mm)
Hauteur (624mm | 774mm | 924mm | 1074mm | 1224mm | 1374mm | 1524mm | 1674mm | 1824mm)



OPTION BOÎTE
AUX LETTRES
MAIL BOX
OPTION



AG36-01 (lame 200mm et tôle décorative)

Largeur (Minimum 630mm / Maximum 2070mm)
Hauteur (Minimum 800mm / Maximum 1900mm)



AG36-02 (lame 200mm et tôle décorative)

Largeur (Minimum 630mm / Maximum 2070mm)
Hauteur (Minimum 800mm / Maximum 1900mm)



AG36-03 (lame 200mm et tôle décorative)

Largeur (Minimum 630mm / Maximum 2070mm)
Hauteur (Minimum 800mm / Maximum 1900mm)



AG36-04 (lame 200mm et tôle décorative)

Largeur (Minimum 630mm / Maximum 2070mm)
Hauteur (Minimum 800mm / Maximum 1900mm)



AG36-05 (lame 200mm et tôle décorative)

Largeur (Minimum 630mm / Maximum 2070mm)
Hauteur (Minimum 800mm / Maximum 1900mm)



AG36-06 (lame 200mm et tôle décorative)

Largeur (Minimum 630mm / Maximum 2070mm)
Hauteur (Minimum 800mm / Maximum 1900mm)



Choisissez le type de fixation

Choose your fixing solution

Clôture sur muret

Fencing installed on a wall

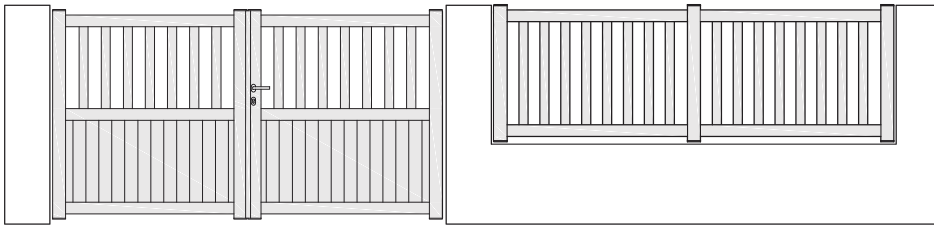

Clôture au sol

Fencing installed directly on the floor

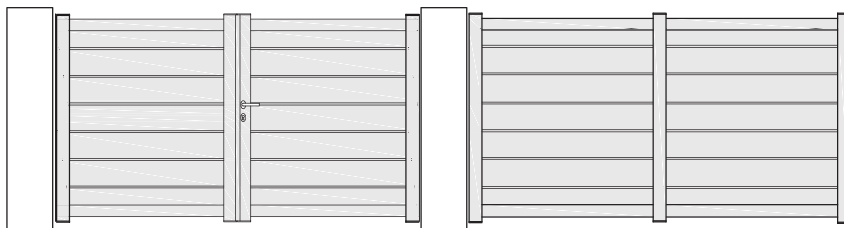

Type de fixation de clôture

Types of fencing fixing

À VISSER

Screwing system with base plate



À SCELLER

Screwing system for application in concrete



L Largeur entre piliers

Width between Pillars

H Hauteur de la Clôture =
Hauteur Visible du Montant

Fence Height = Visible Upright Hinge Height

LC Largeur de la Clôture
= L - 8mm

Fence Width = L - 8mm

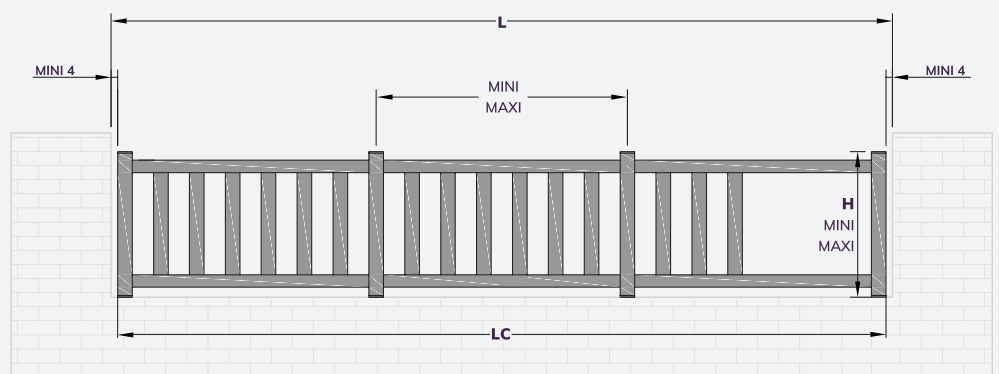

Notre système de clôture à glisser

Our sliding fencing system

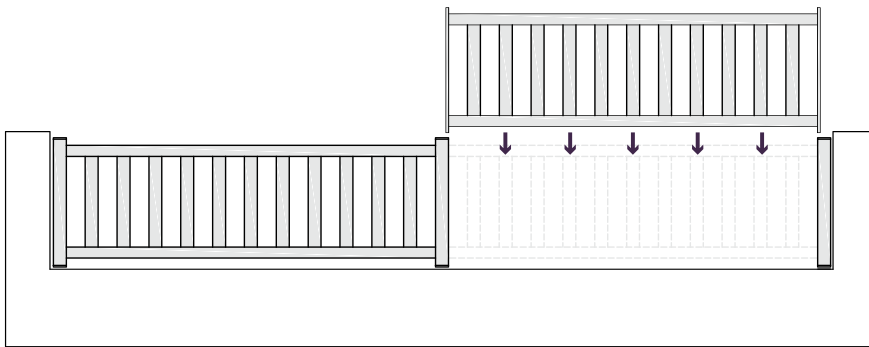

Kit Angulaire

Cornering kit

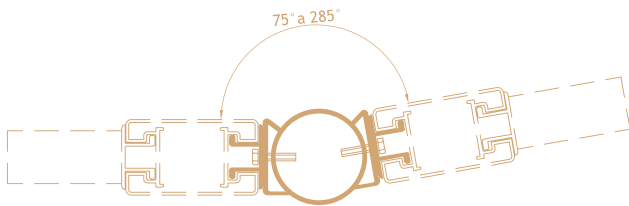

Notre kit angulaire permet d'installer la clôture entre angles de 75° et 285°, pour une fermeture totale de votre propriété.

Our cornering kit allows to install the fencing system in angles between 75° and 285°, for total closure of your property.



- 1 Mesurez la largeur en partant du pilier jusqu'à l'entraxe.

Measure the length from the edge of your wall or fence area to the centre axes of your corner kit.

- 2 Mesurez la largeur en partant de l'entraxe jusqu'au prochain entraxe.

Measure the length between the centre axes of your corner kits.

- 3 Mesurez la largeur en partant de l'entraxe jusqu'au pilier.

Measure the length from the centre axes of your corner kit to the edge of your wall or fence area.

Si votre clôture a trois angles, suivre cette logique puis mesurez la 4ème largeur en partant de l'entraxe jusqu'au pilier.

If your fence has 3 corner kits, follow the same procedure as previously described.





PALISSADES

PALISSADES



Adaptable à la forme et taille de n'importe quel sol

Adaptable to the shape and size of your outdoor space.

Appliqué sur mesure, ce système s'adapte parfaitement à la configuration du terrain, permettant de modeler l'espace extérieur en délimitant la propriété ou en créant des séparations, en fonction de vos besoins. La création de différents niveaux de séparation permet de concevoir un environnement décoratif ou utile dans une terrasse ou jardin, quelle que soit la taille ou la forme.

The palisades system can be customized in order to perfectly adapt to the shape and size of your outdoor space. You can also use this system to divide your garden according to your needs and purposes, building your own and unique decorative solution.

Brise-vent pour un confort assuré

Windshield for guaranteed confort

La palissade est personnalisable, pouvant être installée dans les zones du jardin ou de la terrasse plus exposées au vent. Il suffit d'utiliser une palissade plus élevée dans les zones nécessitant une plus grande protection pour assurer votre tranquillité et bien-être et profiter ainsi de vos espaces extérieurs à n'importe quel moment de la journée.

The palisades are suited to be used as a windshield in areas where your garden is more affected by the wind. By creating a protection against the wind, the palisades system makes a cosier and more comfortable outdoor ambiance for you and your family, regardless of the time of the day or the year.

Profitez de votre espace extérieur en toute intimité et confort

Enjoy your outdoor space in complete privacy and confort

La gamme Gardengate de palissades est un système de clôture en aluminium thermolaqué, très solide, que vous pouvez installer facilement en combinant les différents modules disponibles.

Adaptable à la forme et taille de n'importe quel sol, le système de palissades est le moyen le plus efficace pour assurer le confort et l'intimité de votre jardin, terrasse ou piscine.

Gardengate palisades range is constituted of powdercoated aluminium highly resistant fences. They are extremely easy to install and allow you to build various combinations from the available fencing models.

Adaptable to any size and shape of terrain, this range allows you to enjoy the full benefits of your outdoor living space, in total privacy and confort.

La vie privée de votre famille est garantie

Your family privacy is guaranteed

Pour que vous profitiez à 100% de l'espace extérieur de votre maison, il est indispensable que celui-ci permette une bonne qualité de vie. Avec les palissades en aluminium thermolaqué Gardengate, il est possible de délimiter la surface et la hauteur de l'espace extérieur, afin que votre famille puisse se détendre autour de la piscine ou d'un barbecue en toute intimité.

Your outdoor space should provide you with confort, privacy and memorable moments. With the aluminium palisades system you can enjoy all of this with your family and friends in your garden or barbecuing around your swimming pool.

Modèles avec tôle décor

Models with decorated aluminium sheet



Design 01



Design 02



Design 03



Design 05

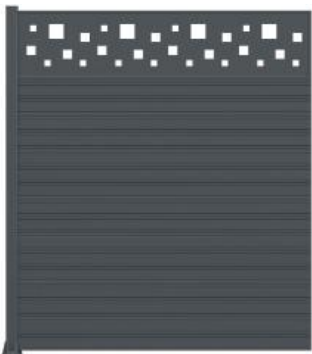

Design 07



Design 08



Design 12

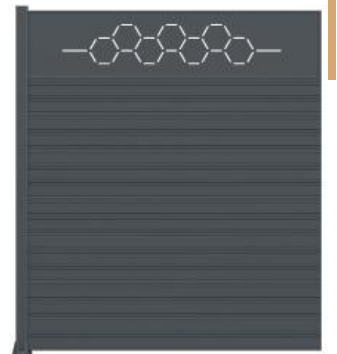

Système de fixation de palissades

Palisade fixing system

À VISSER

Baseplated



À SCELLER

In concrete

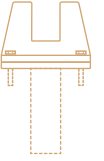

Composition du Système

System Composition

KIT 1 Poteau (Pose Visser)+ 2x Parcloses
Post (Screw Installation) + 2x Glazing beads

KIT 2 Poteau (Pose Sceller)+ 2x Parcloses
Post (Concrete Installation) + 2x Glazing beads

KIT 3 Embout de poteau
Post cap

KIT 4 Base pour poteau visser
Base for screw post

KIT 5 Base acier pour sceller
Steel base for concrete

Possibilité d'assembler toutes les pièces individuelles avec les dimensions indiquées, construisant ainsi une palissade adaptée à vos besoins.

Assemble all the individual pieces, with the dimensions indicated, thus building a palisade adapted to your needs.

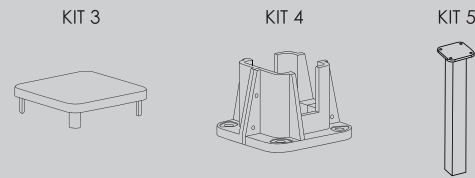
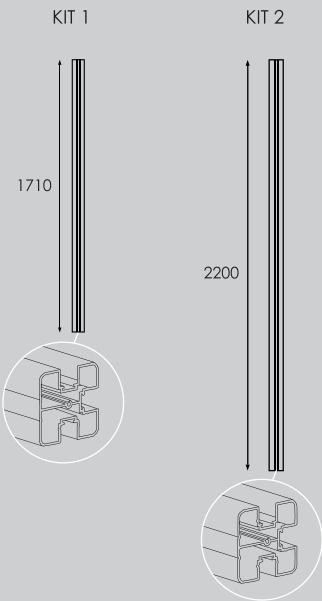

KIT 7 3x Lames de remplissage
3x Filler blades

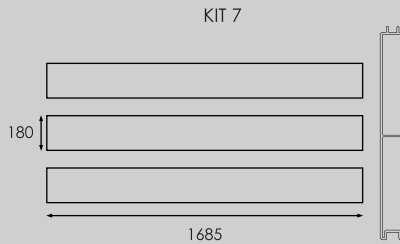

KIT 6 Lames de finition + 4x Pièce fixation
Finishing blades + 4x Fixing pieces

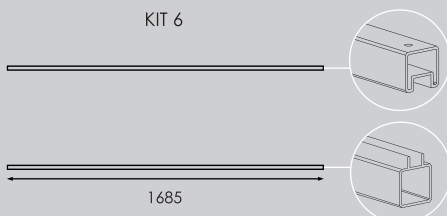

KIT 8 Option Design 01

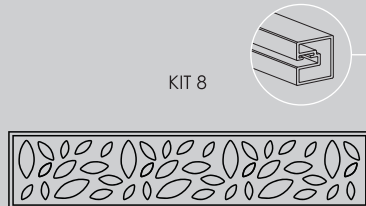

Choix parmi 12 tôles décoratifs différents.
Choose from 12 different decorative aluminium sheets.

Exemples d'assemblage

Assembly Examples

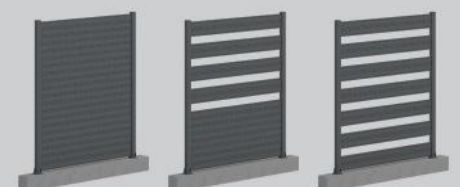
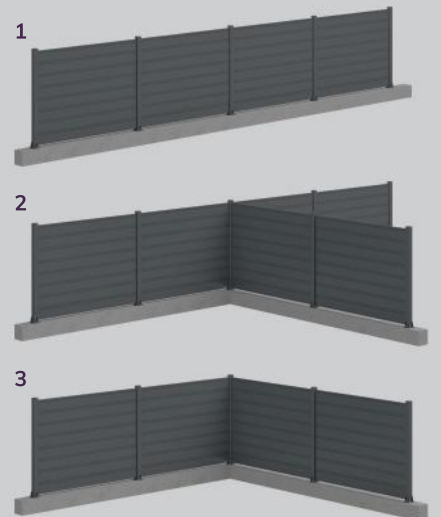

Plein / Full Fill Semi-ajouré / Semi-Open Ajouré / Open



POTEAUX DÉCORATIFS

DECORATIVE POSTS

Types



OPTION DE POTEAU DÉCORATIF AVEC ÉCLAIRAGE À LED LATÉRAL BLANC
DECORATIVE POST WITH LED LIGHTING OPTION ON THE SIDES



RGB LED L'ÉCLAIRAGE OPTION DE POTEAU DÉCORATIF
FRONTAL RGB LED LIGHTING AVAILABLE AS OPTION FOR POSTS WITH POLYCARBONATE PLATES

TÉLÉCOMMANDE
REMOTELY CONTROLLED LED LIGHTING

Décors Designs

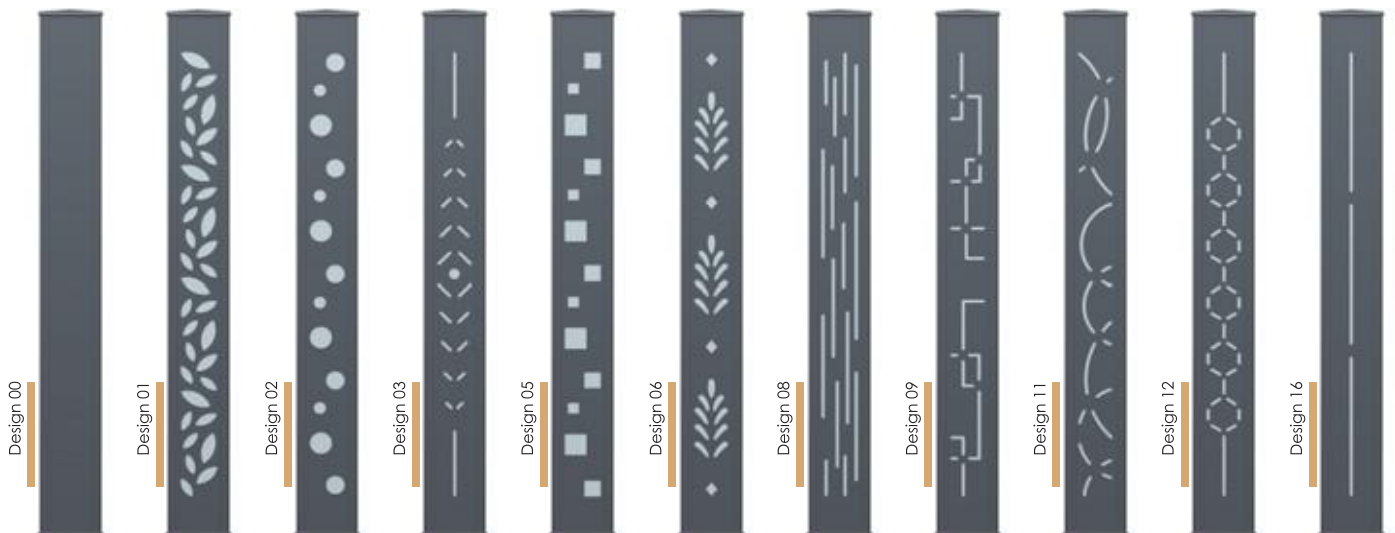

Options

NUMÉRO D'ENTRÉE + CARACTÈRES ALPHABÉTIQUES

Residence number + alphabetic characters

Pour mieux identifier l'entrée de votre maison, vous avez l'option de personnaliser votre poteau avec des caractères alphanumériques.

In order to provide a better identification of your residence you have the option of customizing your posts with alphanumeric lettering.

0123456789
 ABCDEFGHIJKLMN
 OPQRSTUVWXYZ

EMPLACEMENT ET DIMENSIONS

Position and Dimensions

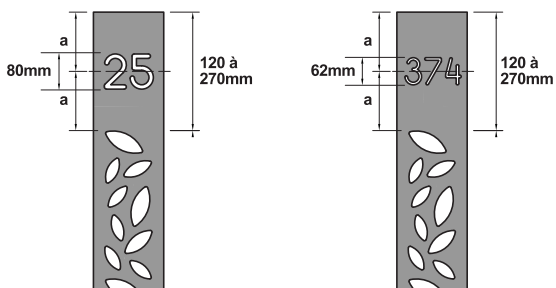

(a) Position centrée en hauteur
 Position centered in height

Jusqu'à 3 caractères numériques et alphabétiques
 Up to 3 numerical and alphabetical lettering



CARACTÉRISTIQUES TECHNIQUES

Features

En prenant en compte le type de votre sol, vous pouvez choisir le poteau à visser ou à sceller.

According to the soil type, you can choose between posts baseplated or in concrete.

POTEAU DÉCORATIF Decorative Post 200X200mm

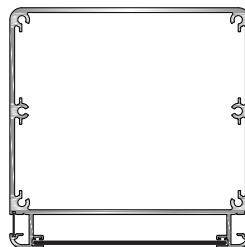

À SCELLER
 In concrete



À VISSER
 Baseplated

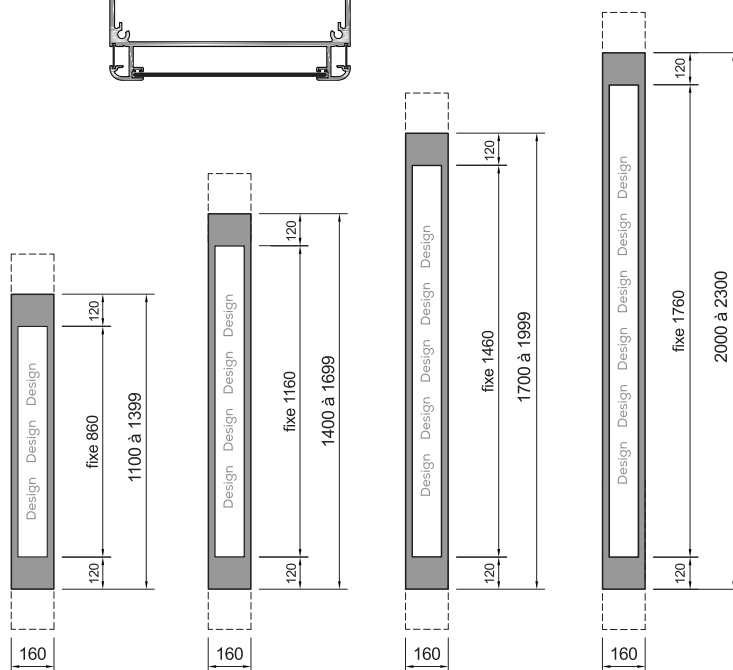

POTEAUX CLASSIQUES

CLASSIC POSTS



100x100mm

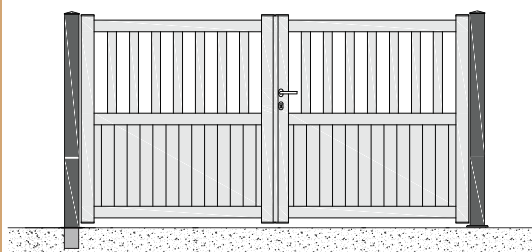
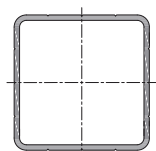

150X150mm

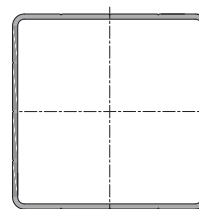

À SCELLER
In concrete



À VISSER
Boseplated





TOTEM BOÎTE AUX LETTRES

MAILBOXES



ASC01 (lame 100mm)



ASC02 (lame 200mm)



ASC03 (lame 284mm)



ASC05 (profil décor 15mm et lame 200mm)



ASC06 (tube 100mm)



ASC04 (tôle)

Option

NUMÉRO D'ENTRÉE + CARACTÈRES ALPHABÉTIQUES

Residence number + Alphabetical characters

Option uniquement disponible sur les modèles ASC01 à ASC06.

Les modèles ASC07 à ASC09, ce n'est pas possible.

Option just available for the models ASC01 to ASC06.

Models ASC07 to ASC09 can't have this option.

0123456789

ABCDEFGHIJKLMN
OPQRSTUVWXYZ

Jusqu'à 4 caractères numériques et alphabétiques

Up to 4 numerical and alphabetical lettering



ASC09 (tube 250mm)



ASC07 (lame 250mm)



ASC08 (Profil décor 15mm et 250mm)

CARACTÉRISTIQUES TECHNIQUES

Features

FIXATION MURALE / POTEAU

Attached to the wall / post



FIXATION AU SOL

Directly attached to the ground

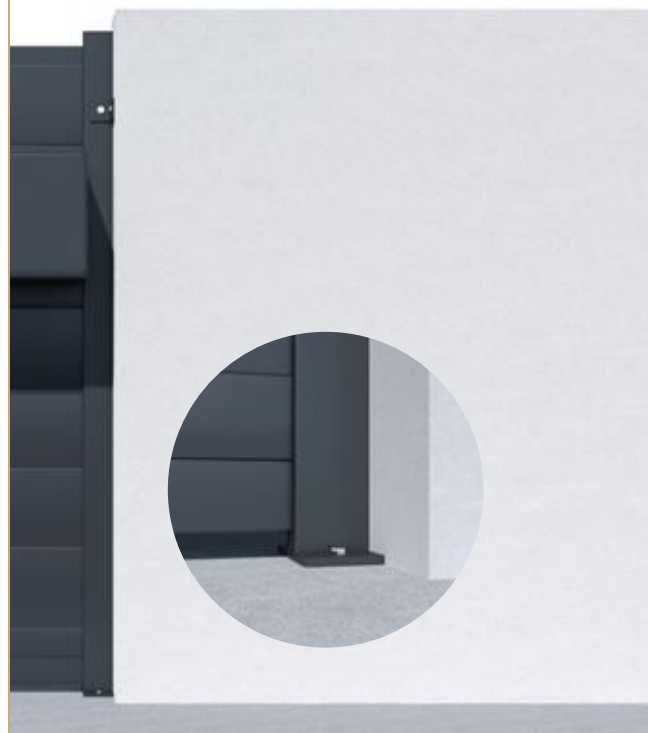

BOÎTE AUX LETTRES

Mailbox



Laquée /
Powdercoated

DIMENSIONS

Largeur / Width (285mm)
Longueur / Length (400mm)
Hauteur / Height (285mm)

TOTEM

DIMENSIONS

Largeur / Width (426mm)
Hauteur / Height
ASC01 à ASC05: 1377 à 2200mm
ASC06: 1377 à 2087mm
ASC07: 1552 / 1802 / 2052mm
ASC08: 1597 / 1862 / 2127mm
ASC09: 1612 / 1882 / 2152mm

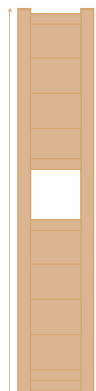

L'ouverture de la boîte aux lettres
Opening for the mailbox

Hauteur / Height
Hauteur environ 1000mm
(peut aller de 830mm à 1100mm)

SPÉCIAL



LES BOIS

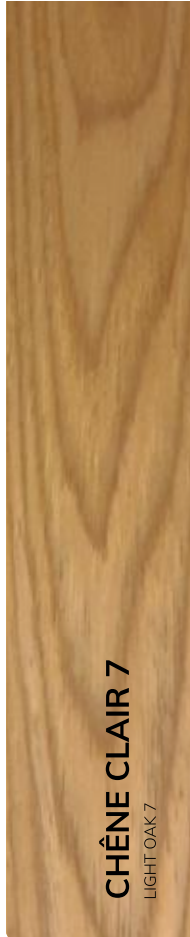
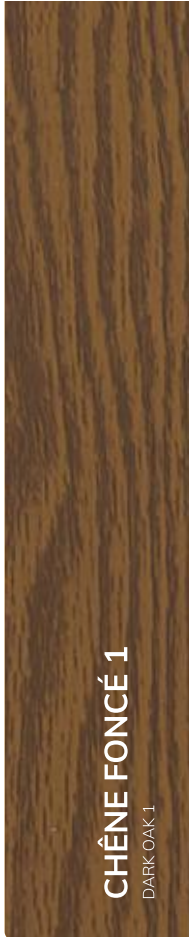

COULEURS

COLOURS

Couleurs spéciales disponibles avec plus value
Special colours available with an additional cost

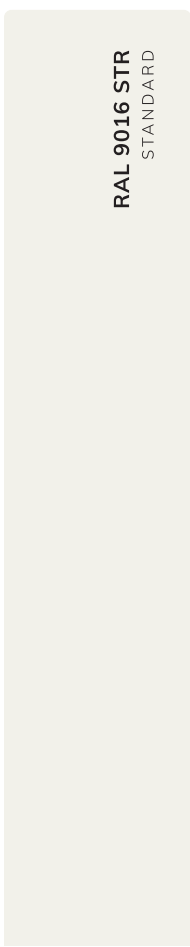
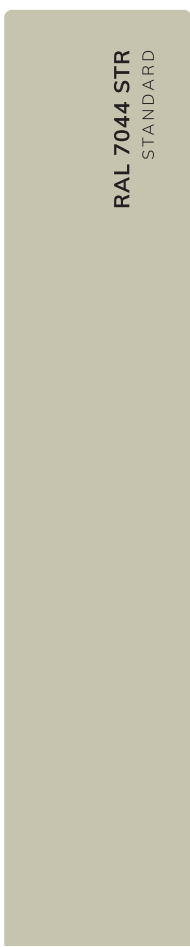
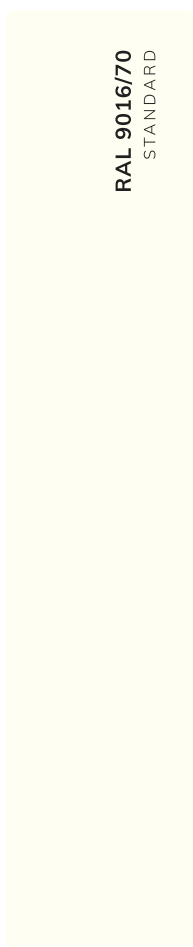

RAL 8019 STR
STANDARD

RAL 6005 STR
STANDARD

RAL 3004 STR
STANDARD

RAL 5003 STR
STANDARD

RAL 9005 STR
STANDARD

RAL 8014 STR
STANDARD

RAL 7016 STR
STANDARD

COULEURS PERSONNALISÉES SUR DEMANDE
CUSTOMIZED COLOURS ON DEMAND



RAL 7016/70
STANDARD

RAL 5014 STR
STANDARD

RAL 7031 STR
STANDARD

GRIS SABLÉ 2900
STANDARD

RAL 9007 STR
STANDARD

RAL 7039 STR
STANDARD

RAL 6021 STR
STANDARD